

rolly toys Kundendienst Deutschland:

Tel: +49 (0) 95 68 / 856-142
 Fax: +49 (0) 95 68 / 856-183
 e-mail: service@rollytoys.de

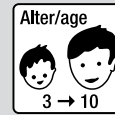

2022/05

959.000.800.00

CAUTION ELECTRIC TOY!

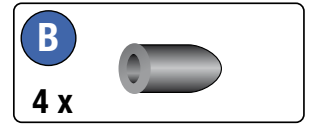
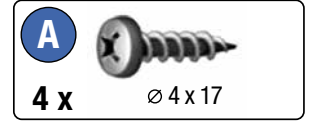
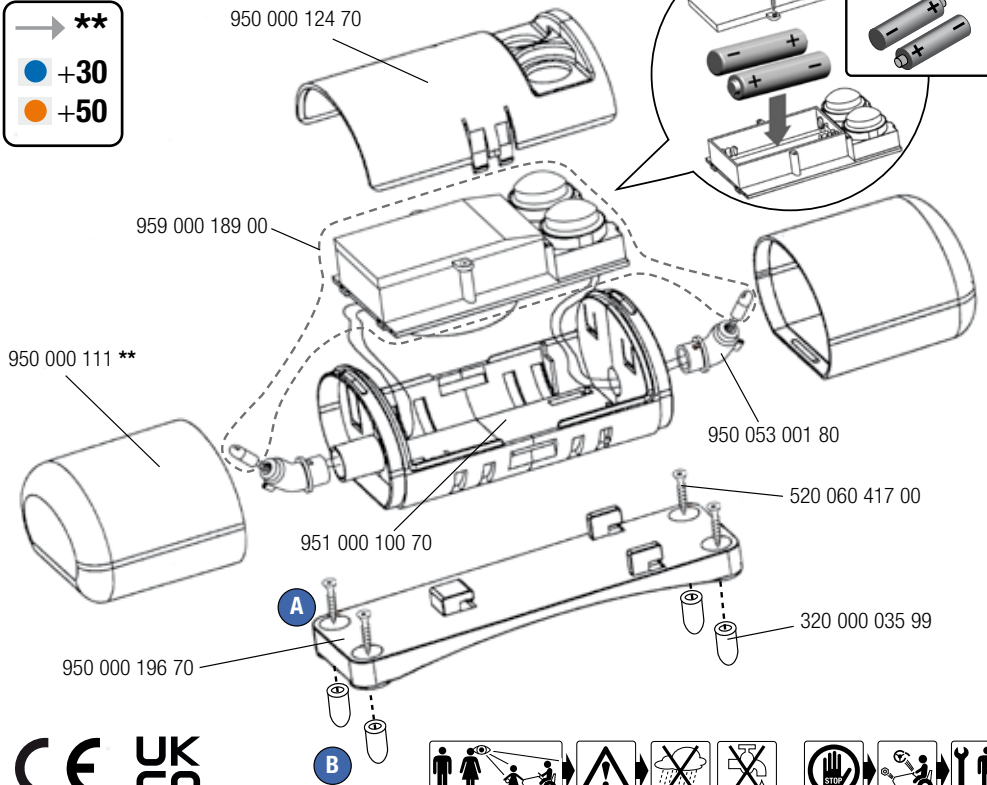
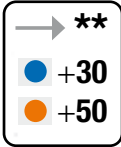

- (BG) Предупреждение!
- (CZ) Varování!
- (D) Achtung!
- (DK) Advarsel!
- (E) Aviso!
- (EST) Hoiatus!
- (F) Attention!
- (FIN) Varoitus!
- (GB) Warning!
- (GR) Προσοχή!
- (H) Figyelmeztetés!
- (HR) Pažnja!
- (I) Avviso!
- (IRL) Rabhchán!
- (LT) Įspėjimas!
- (LV) Uzmanību!
- (M) Aviz!
- (MK) Внимание!
- (N) OBS!
- (NL) Waarschuwing!
- (P) Aviso!
- (PL) Ostrożnie!
- (RO) Avertisment!
- (RUS) Внимание!
- (S) Varning!
- (SK) Varovanie!
- (SLO) Opozorilo!
- (TR) Dikkat!

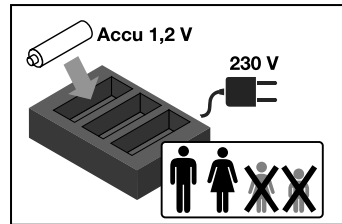
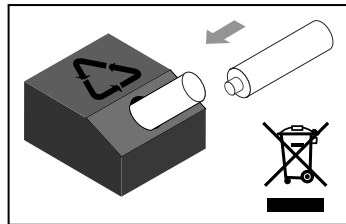
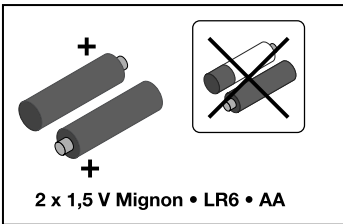

WARNING:
CHOKING HAZARD – Small parts.
 Not for children under 3 years.

WARNING

- CHOKING HAZARD - Small parts, Danger of being swallowed. Contains small parts in non assembled state. Must be assembled by adults.
- If toy is defective stop using it, repairs may only be carried out by adults.
- Adult supervision required.
- The stickers are to be applied by adults only.
- Conforms to the requirements of ASTM Standard Consumer Safety Specification on Toy Safety, F 963.

AVERTISSEMENT

- RISQUE D'ÉTOUFFEMENT - Petites pièces. Risque d'ingestion. Contient des petites pièces à l'état non assemblé. Doit être assemblé par un adulte.
- Si le jouet est défectueux, cessez de l'utiliser. Toute réparation ne doit être effectuée que par un adulte.
- Surveillance d'un adulte est requise.
- Les autocollants ne doivent être appliqués que par des adultes.
- Conforme aux exigences de la norme internationale ASTM Standard Consumer Safety Specification on Toy Safety, F 963.

--- NORTH & SOUTH AMERICA only ---

180 days warranty

From the date of purchase + guaranteed spare part service

The warranty does not cover damages caused by improper use or neglect



Franz Schneider GmbH & Co KG
 Siemensstrasse 13-19
 D-96465 · Neustadt bei Coburg · Germany
 Tel.: +49 (0) 95 68 / 856-0
 Fax.: +49 (0) 95 68 / 856-190
 www.rollytoys.com