

rolly[®] trac lader



rolly toys Kundendienst Deutschland:

Tel: +49 (0) 95 68 / 856-142

Fax: +49 (0) 95 68 / 856-183

e-mail: service@rollytoys.de

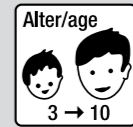

2023/12

934.000.800.00

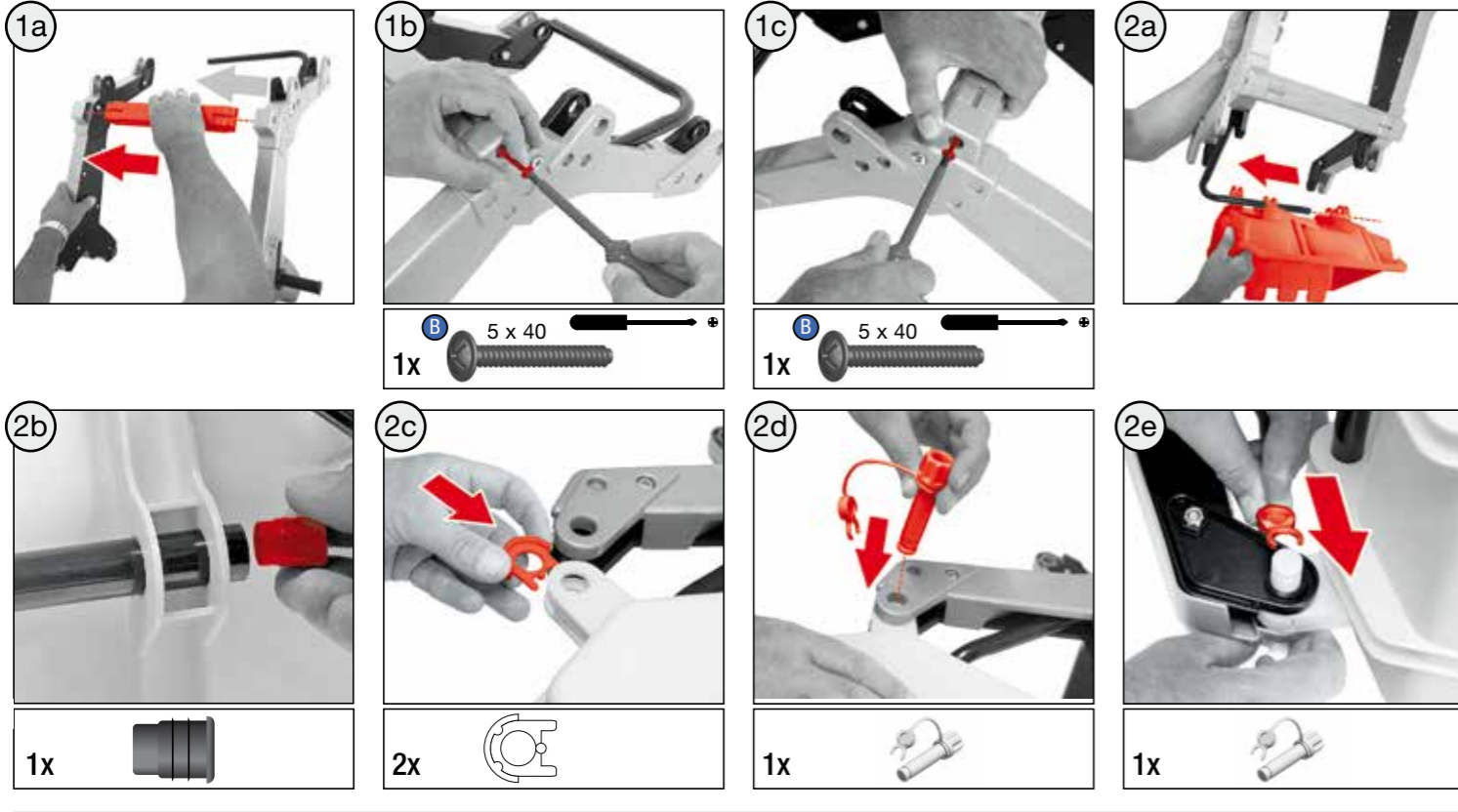

! WARNING

- CHOKING HAZARD - Small parts, Not for children under 3 years.
- Must be assembled by adults
- Adult supervision required.
- Toy is not suitable to carry children.
- If toy is defective stop using it, repairs may only be carried out by adults.
- Never use near steps, slopes, driveways, hills, roadways, alleys or swimming pool areas.
- Always wear shoes.
- The stickers are to be applied by adults only.
- Conforms to the requirements of ASTM Standard Consumer Safety Specification on Toy Safety, F 963.



! AVERTISSEMENT

- RISQUE D'ÉTOUFFEMENT - Petites pièces. Ne convient pas aux enfants de moins de 3 ans.
- Doit être assemblé par un adulte.
- Surveillance d'un adulte est requise.
- Le jouet ne convient pas au transport des enfants.
- Si le jouet est défectueux, cessez de l'utiliser. Toute réparation ne doit être effectuée que par un adulte.
- Ne jamais utiliser à proximité des marches, des pentes, des allées, des collines, des routes, des allées ou des piscines.
- Portez toujours des chaussures.
- Les autocollants ne doivent être appliqués que par des adultes.
- Conforme aux exigences de la norme internationale ASTM Standard Consumer Safety Specification on Toy Safety, F 963.

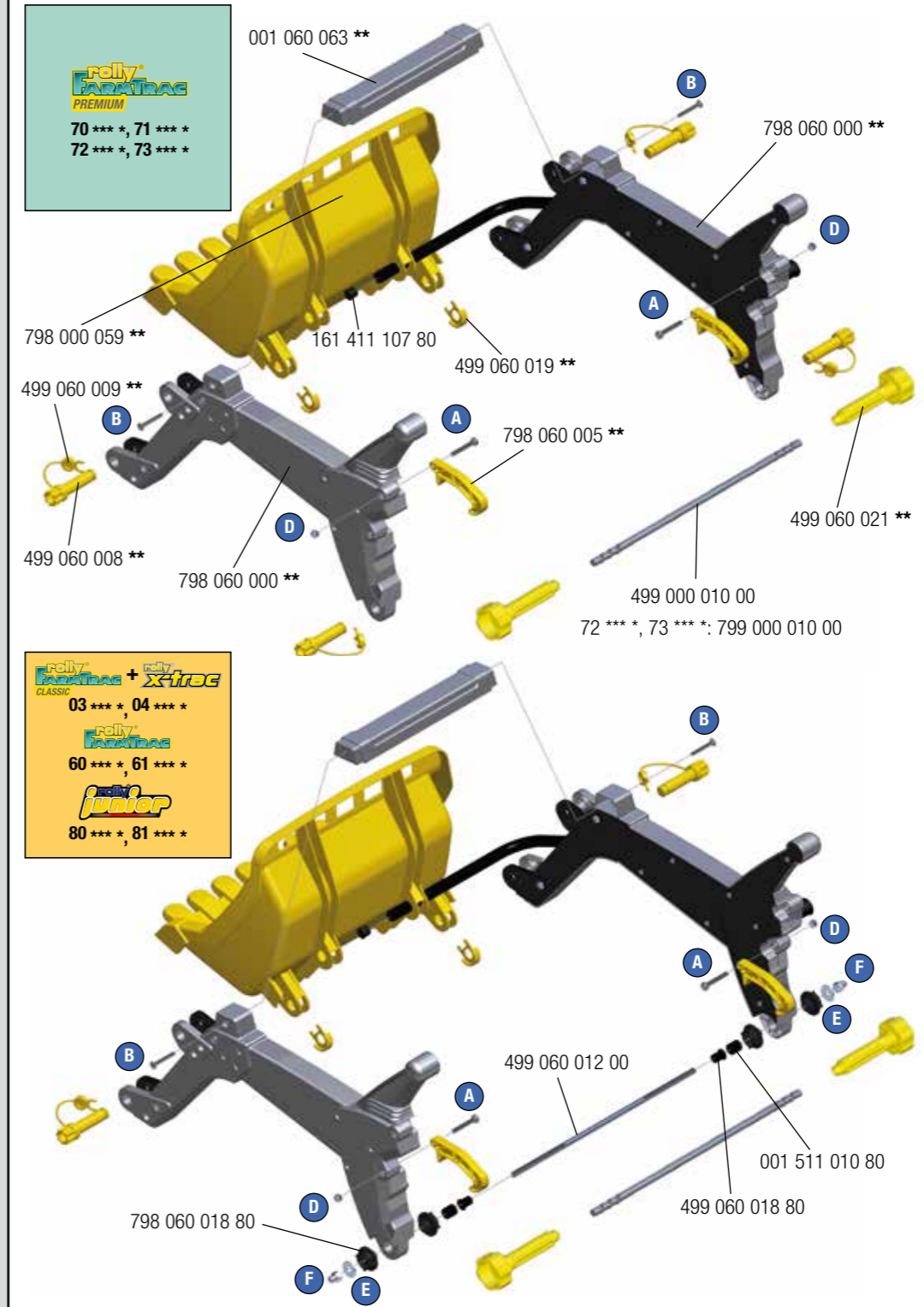

rolly[®]
FABRITRAC
PREMIUM
70 *** , 71 ***
72 *** , 73 ***

rolly[®]
FABRITRAC +
X-TRAC
CLASSIC
03 *** , 04 ***
60 *** , 61 ***
junior
80 *** , 81 ***

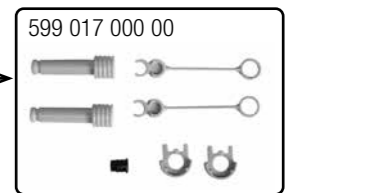
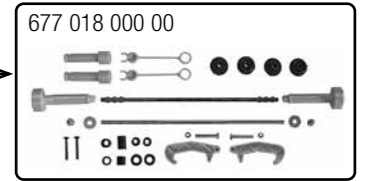

→ **

● +10	● +26	● +47
● +12	● +30	● +51
● +13	● +37	● +54
● +20	● +40	● +70
● +22	● +41	● +75
● +23	● +44	● +80

--- NORTH & SOUTH AMERICA only ---
180 days warranty

From the date of purchase + guaranteed spare part service
The warranty does not cover damages caused by improper use or neglect

made in Germany

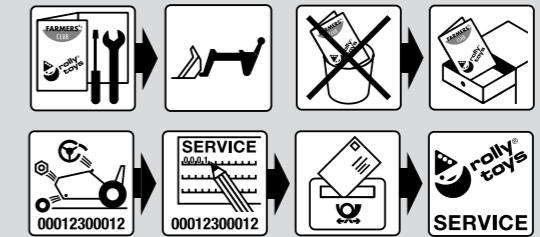

Franz Schneider GmbH & Co KG
P.O.Box 1460
D-96459 - Neustadt bei Coburg · Germany
Tel.: +49 (0) 95 68 / 856-0
Fax.: +49 (0) 95 68 / 856-190
www.rollytoys.com

rely[®]
FARATRAC
PREMIUM

70 *** , 71 *** *
72 *** , 73 *** *
(A - I)

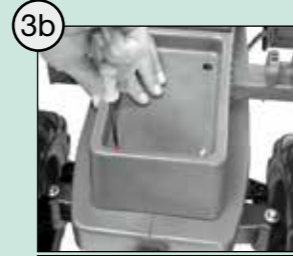
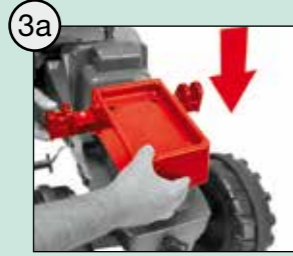

B 5 x 40
2x **C** 3 x 20

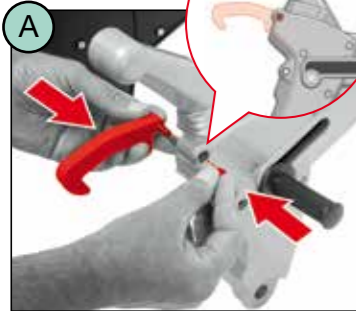
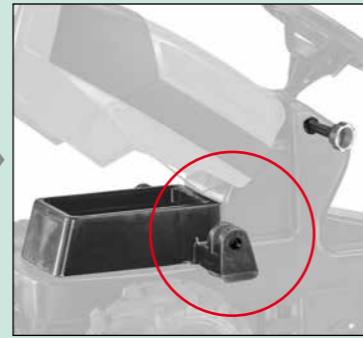

A M6 x 40
1x **D** M6

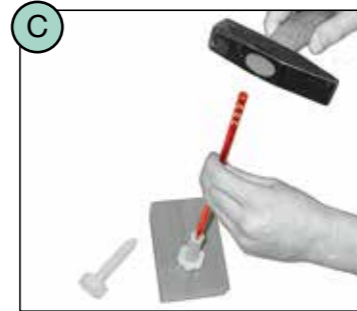
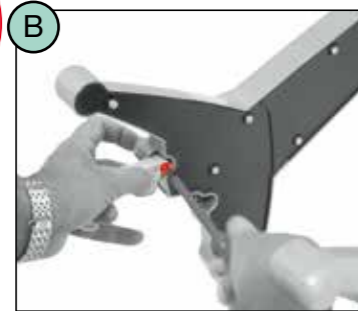

1x

70 *** , 71 *** *:
∅ 8 x 335mm
72 *** , 73 *** *:
∅ 8 x 330mm

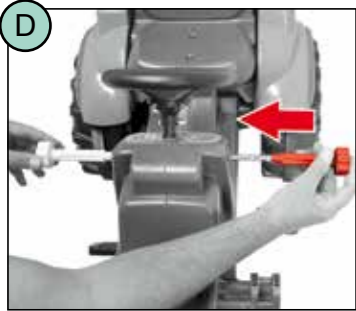

1x

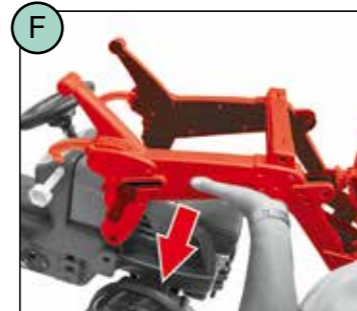
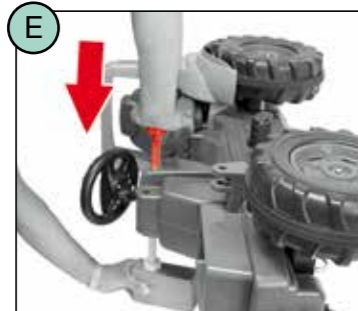

2x

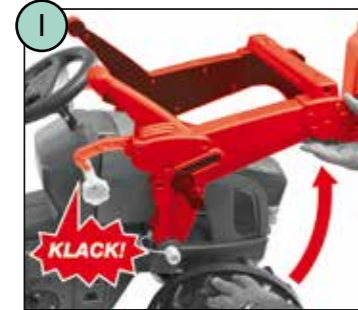
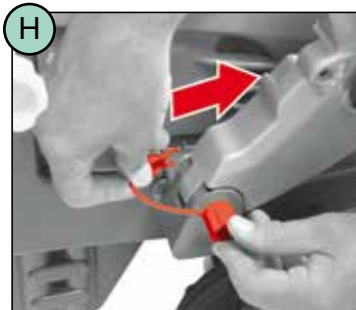

A M6 x 40
2x 798 506 040 00

D M6
2x 098 506 000 00

E ∅8,4 x ∅24
2x 902 184 000 00

F M8
2x 098 608 000 00

B AMTEC 5 x 40
2x 520 060 540 00

C ∅3 x 20
2x 750 503 020 00

0 10 20 30 40 50 mm (metrisch • metric)

rely[®]
FARATRAC
CLASSIC
03 *** , 04 *** *
rely[®]
FARATRAC
60 *** , 61 *** *
rely[®]
junior
80 *** , 81 *** *
(J - Z)

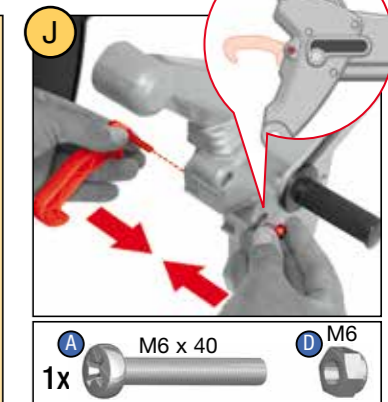
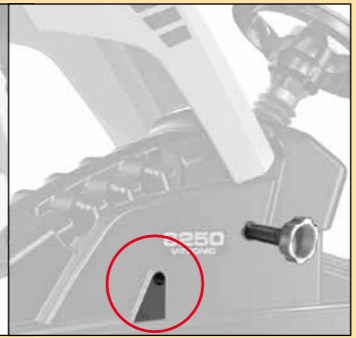
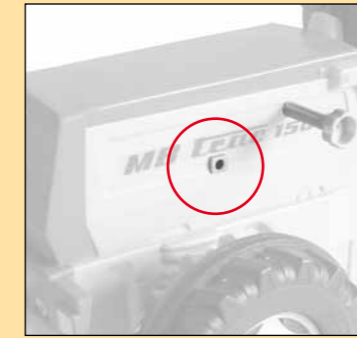

A M6 x 40
1x **D** M6

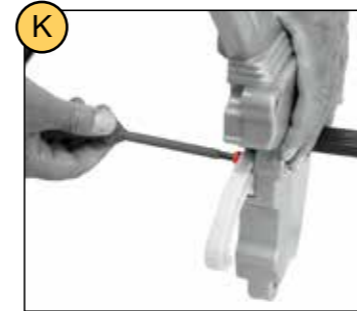

1x

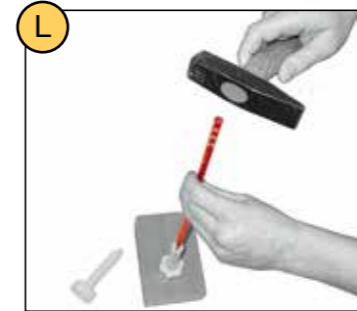

1x ∅8 x 335mm

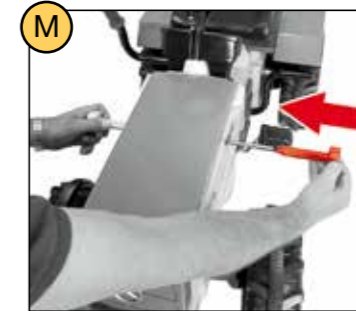

1x

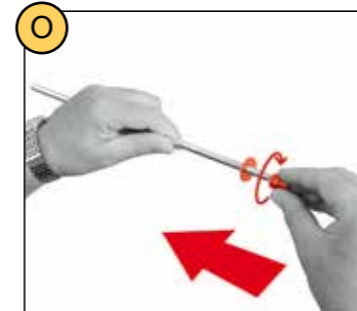
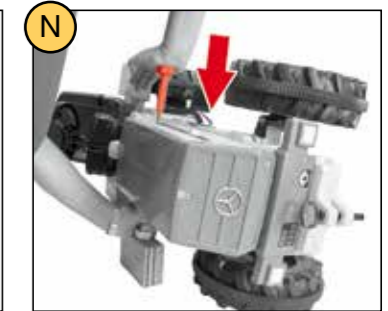

1x ∅8 x 345mm **E** **F**



2x ∅12 x 16mm

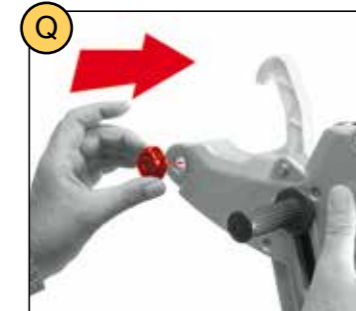

1x



1x

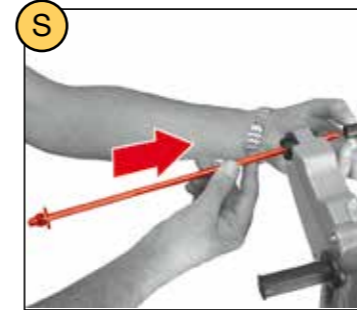

1x

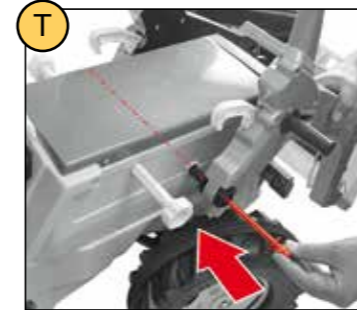

1x

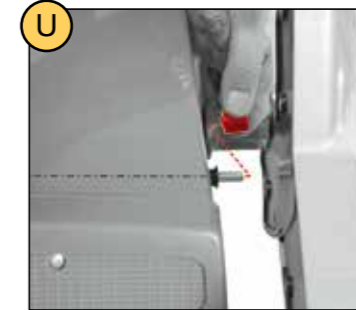

1x

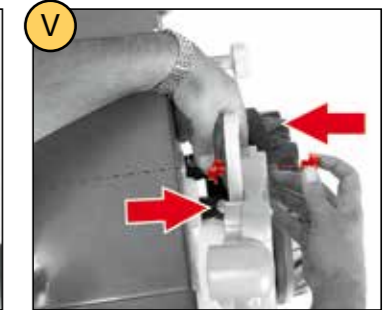

1x



1x **E** ∅8,4 x ∅24

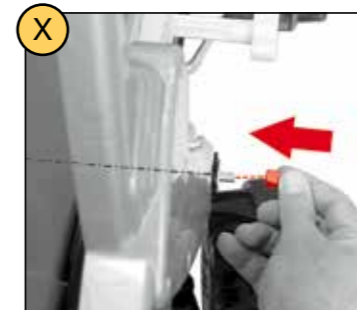

1x **F** M8

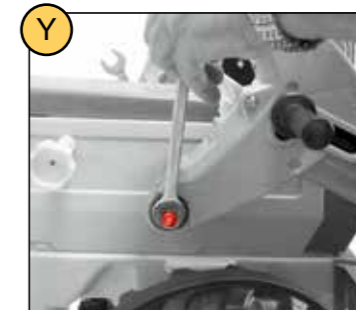

1x 13 13

