

# Luftbereifung

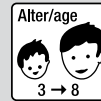

**rolly toys Kundendienst Deutschland:**

Tel: +49 (0) 95 68 / 856-142  
 Fax: +49 (0) 95 68 / 856-183  
 e-mail: service@rollytoys.de



2022/05

**918.000.800.00**

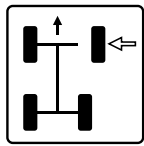
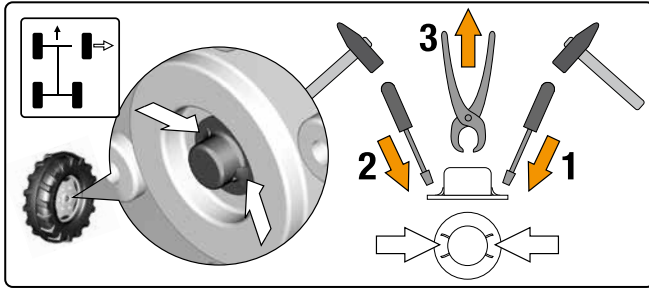

- 918 002 000 12
- 918 002 000 20
- 918 002 000 70
- 918 002 000 75

**A1** (0-3)

BG Предупреждение!	LT Įspėjimas!
CZ Varování!	LV Uzmanību!
D Achtung!	M Avarij!
DK Advarsel!	MK Вниманије!
E Aviso!	N OBS!
EST Hoiatust!	NL Waarschuwing!
F Attention!	P Aviso!
FIN Varoitust!	PL Ostrożnie!
GB Warning!	RO Avertisment!
GR Προσοχή!	RUS Вниманије!
H Figyelmeztetés!	S Varning!
HR Pažnja!	SK Varovanie!
I Avviso!	SLD Opozorilo!
IRL Rabhchán!	TR Dikkat!

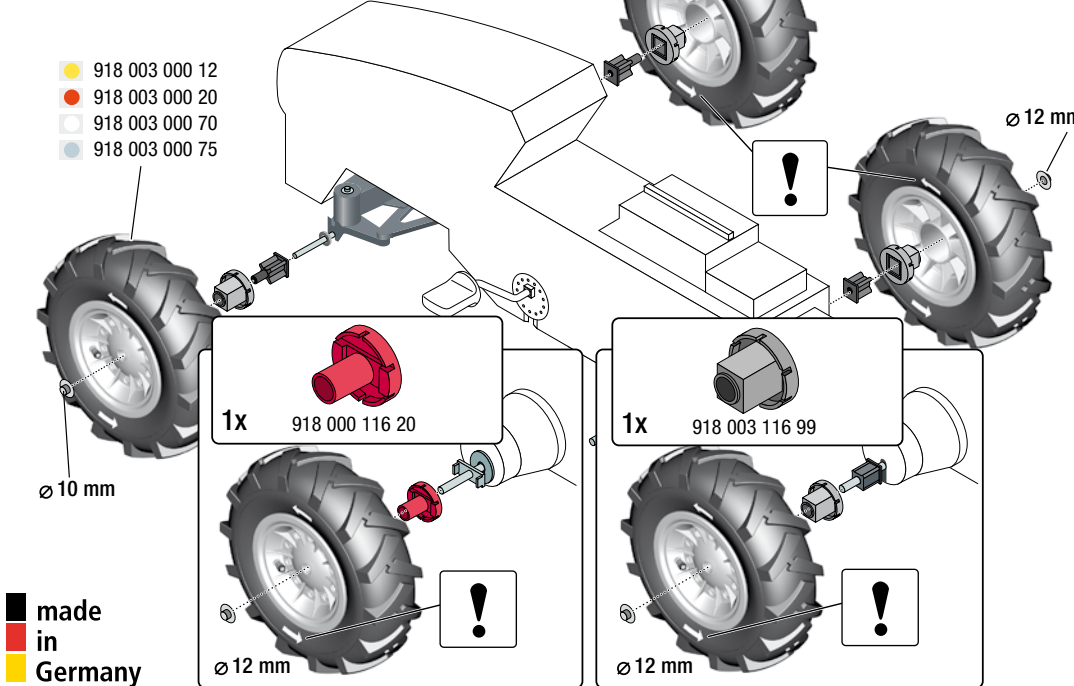
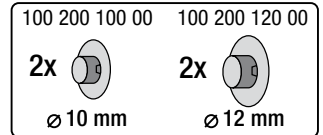
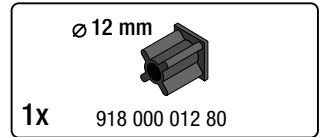
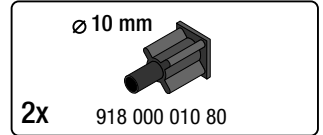

**made in Germany**

## AVERTISSEMENT

- RISQUE D'ÉTOUFFEMENT - Petites pièces. Risque d'ingestion. Contient des petites pièces à l'état non assemblé. Doit être assemblé par un adulte.
- Surveillance d'un adulte est requise
- Ne jamais utiliser à proximité des marches, des pentes, des allées, des collines, des routes, des allées ou des piscines.
- Portez toujours des chaussures.
- Ne permettez jamais la présence de plus d'un coureur.
- L'utilisation d'un équipement de protection et d'un casque de sécurité est fortement recommandée.
- Conforme aux exigences de la norme internationale ASTM Standard Consumer Safety Specification on Toy Safety, F 963.
- Ne convient pas aux enfants de moins de 3 ans.

## WARNING

- CHOKING HAZARD: Small parts. Danger of being swallowed. Contains small parts in non assembled state. Must be assembled by adults.
- Adult supervision required.
- Never use near steps, slopes, driveways, hills, roadways, alleys or swimming pool areas.
- Always wear shoes.
- Never allow more than one rider.
- The use of protective gear and a safety helmet is highly recommended.
- Conforms to the requirements of ASTM Standard Consumer Safety Specification on Toy Safety, F 963
- Not suitable for children under 3 years.

---NORTH & SOUTH AMERICA only---

**180 days warranty**

From the date of purchase + guaranteed spare part service  
 The warranty does not cover damages caused by improper use or neglect



**Franz Schneider GmbH & Co KG**  
 Siemensstrasse 13-19  
 D-96465 · Neustadt bei Coburg · Germany  
 Tel.: +49 (0) 95 68 / 856-0  
 Fax.: +49 (0) 95 68 / 856-190  
 www.rollytoys.com

