



WARNING:

CHOKING HAZARD – Small parts.
Not for children under 3 years.

- CHOKING HAZARD - Small parts, Danger of being swallowed. Contains small parts in non assembled state. Must be assembled by adults.
- If toy is defective stop using it, repairs may only be carried out by adults.
- Adult supervision required.
- Never use near steps, slopes, driveways, hills, roadways, alleys or swimming pool areas.
- Always wear shoes.
- Never allow more than one rider.
- The use of protective gear and safety helmet is highly recommended.
- Conforms to the requirements of ASTM Standard Consumer Safety Specification on Toy Safety, F 963.

VOLVO

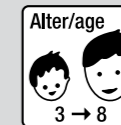

rolly toys Kundendienst Deutschland:

Tel: +49 (0) 95 68 / 856-142
Fax: +49 (0) 95 68 / 856-183
e-mail: service@rollytoys.de

rolly® Truck-Line

2018/07

672.000.800.00

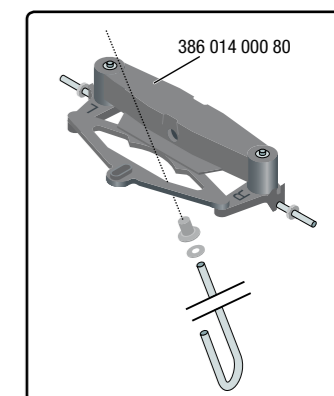
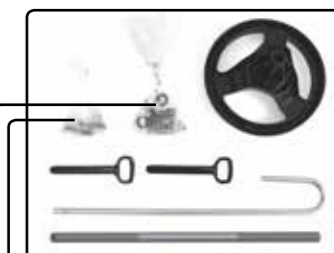
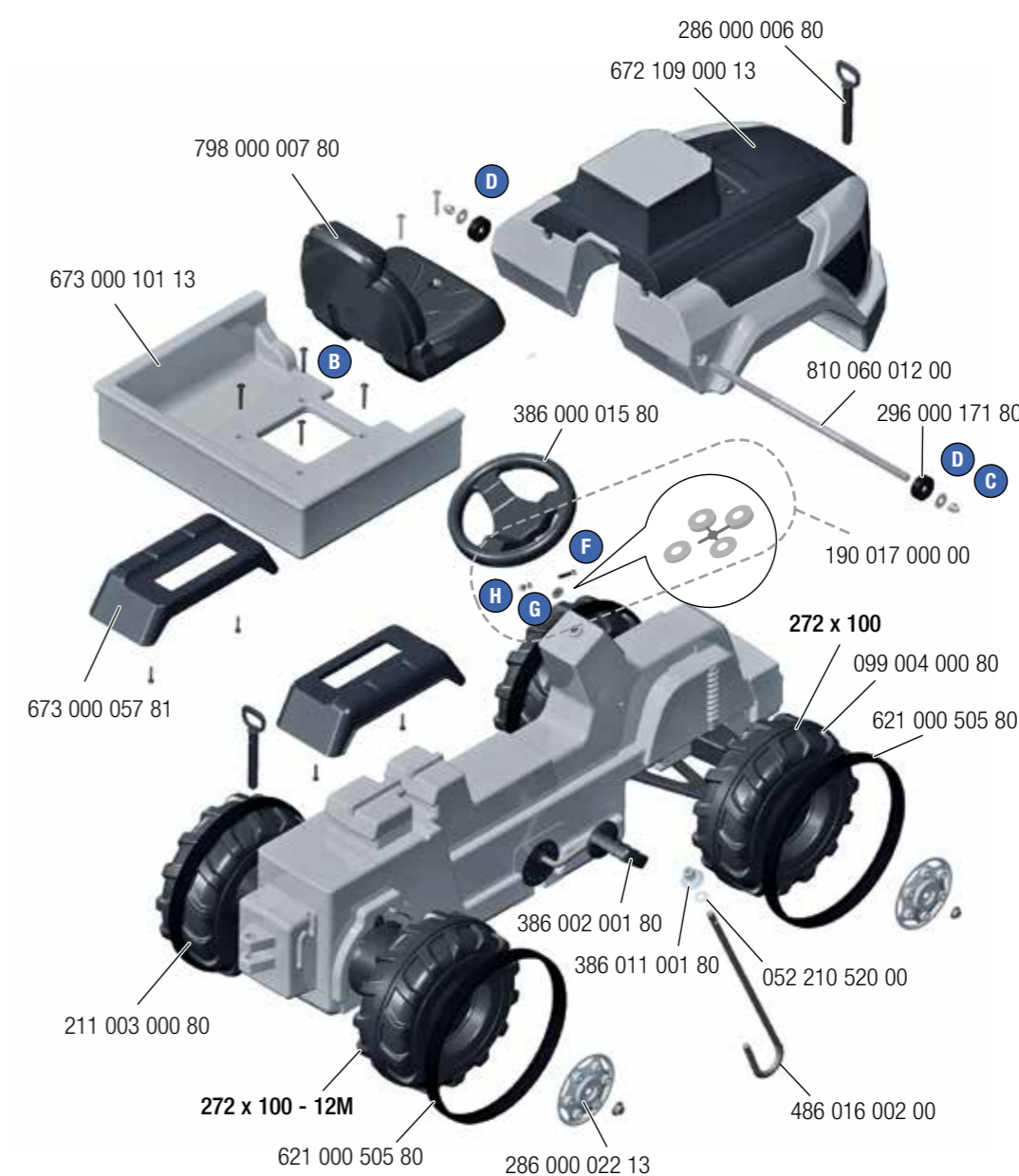
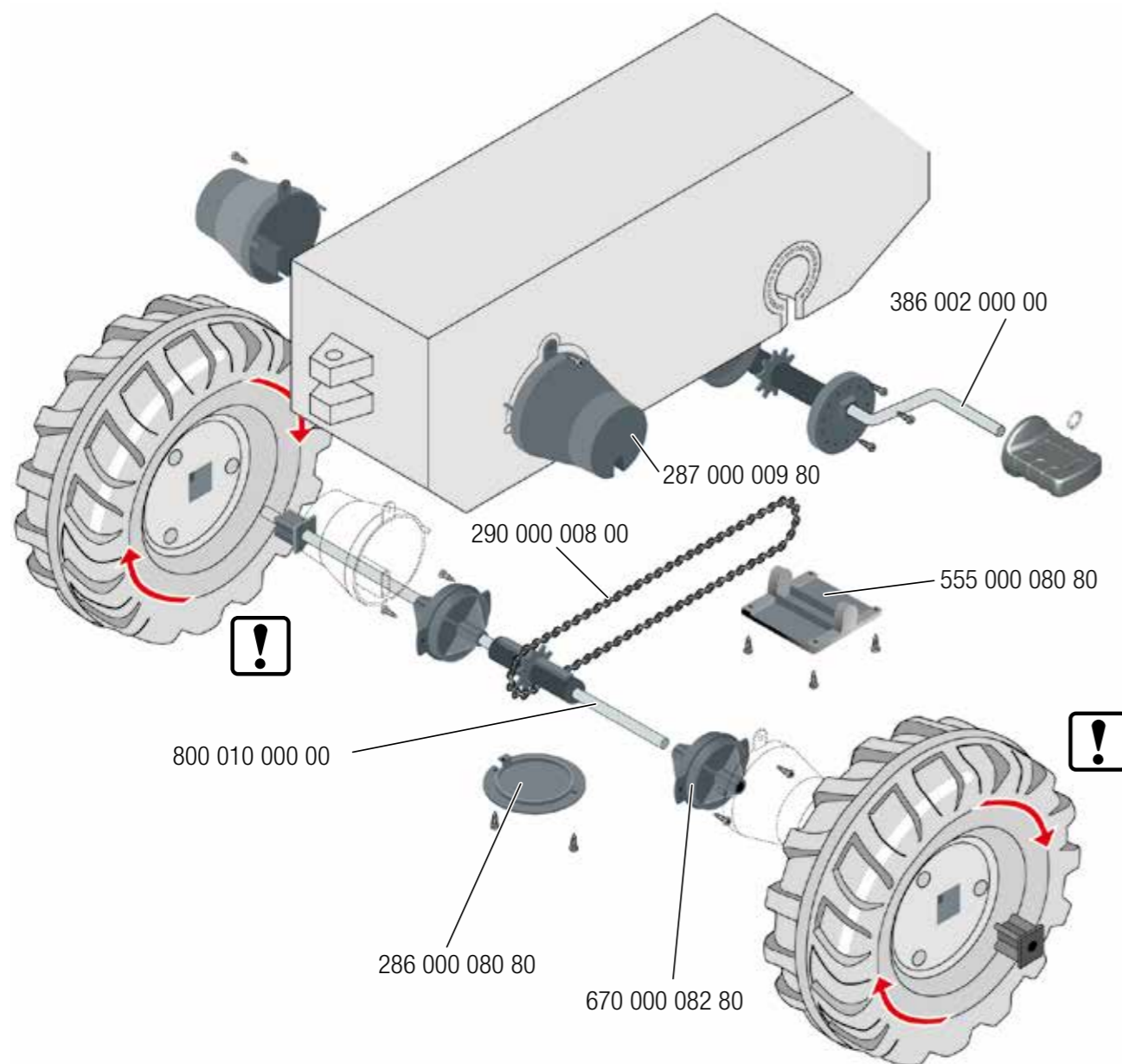

---NORTH & SOUTH AMERICA only---

180 days warranty

From the date of purchase + guaranteed spare part service
The warranty does not cover damages caused by improper use or neglect



made in Germany



Franz Schneider GmbH & Co KG
P.O.Box 1460
D-96459 · Neustadt bei Coburg · Germany
Tel.: +49 (0) 95 68 / 856-0
Fax: +49 (0) 95 68 / 856-190
www.rollytoys.com

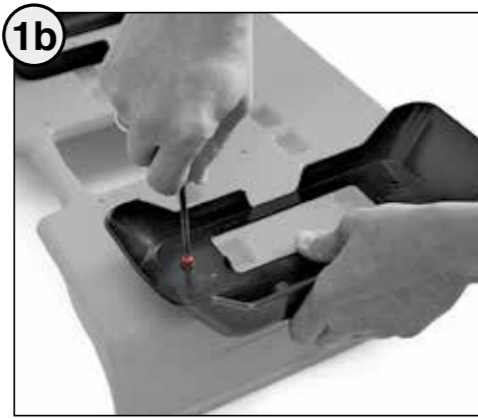
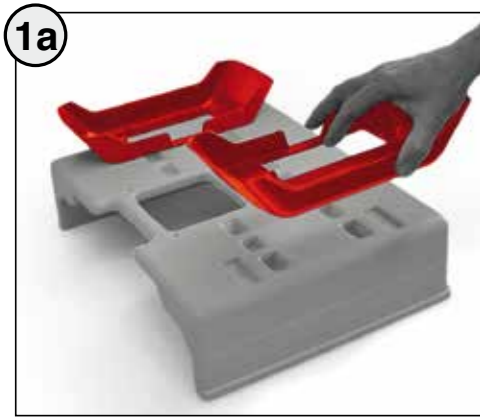

A 4x17
4x

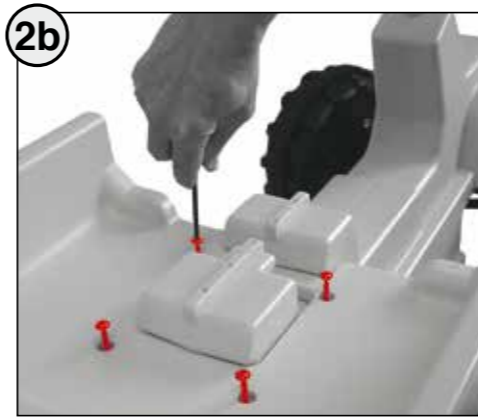
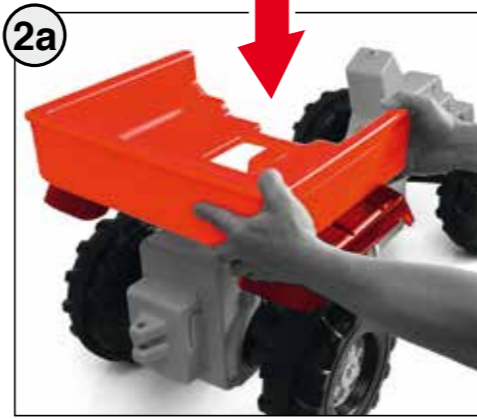

B 5x40
4x

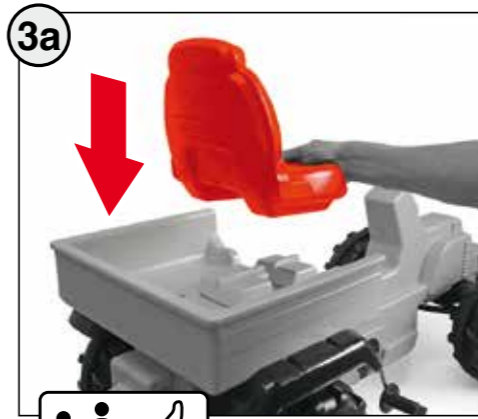

B 5x40
2x

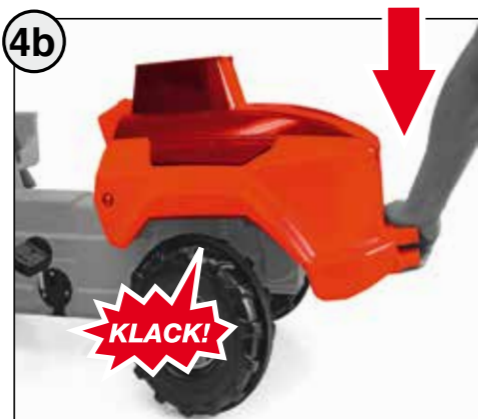
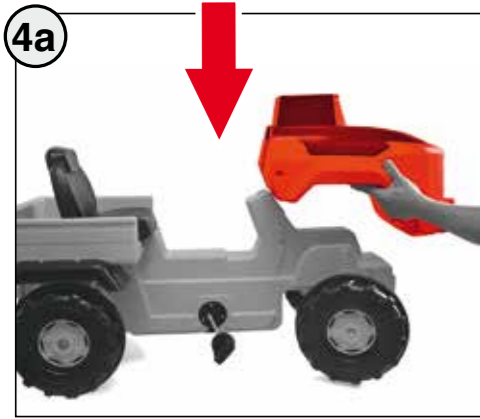

KLACK!

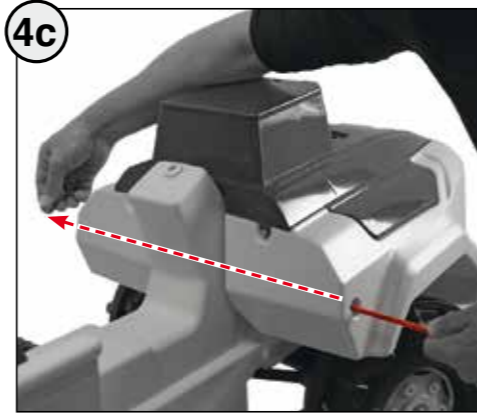

1x $\varnothing 6 \times 418$

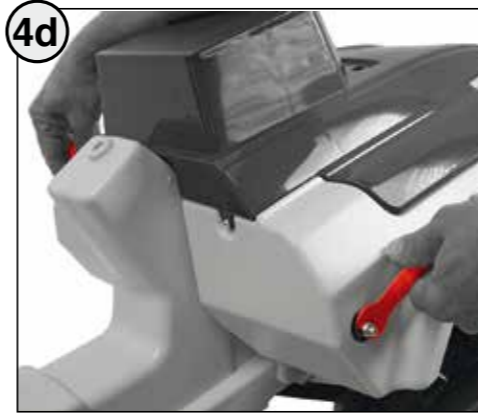

2x **C** 2x **D** 2x 2x
 M6

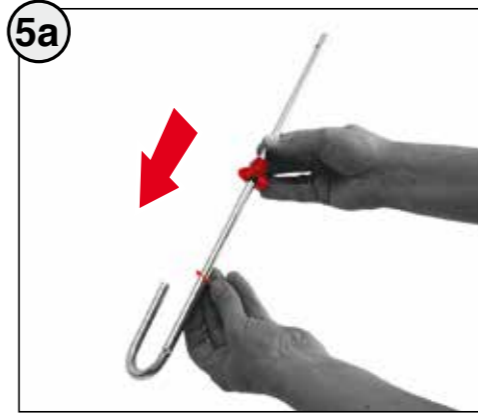

E $\varnothing 20 \times \varnothing 10,5 \times 1$
1x 1x

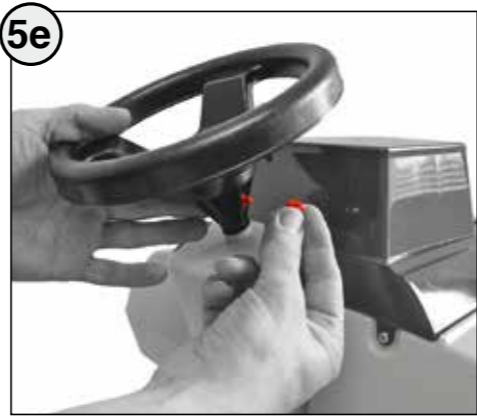
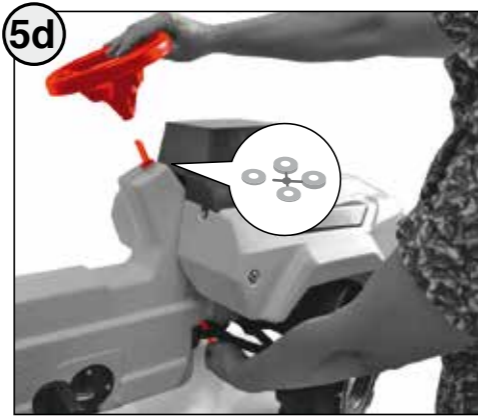
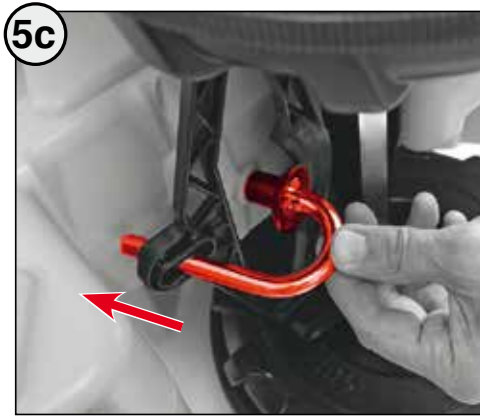
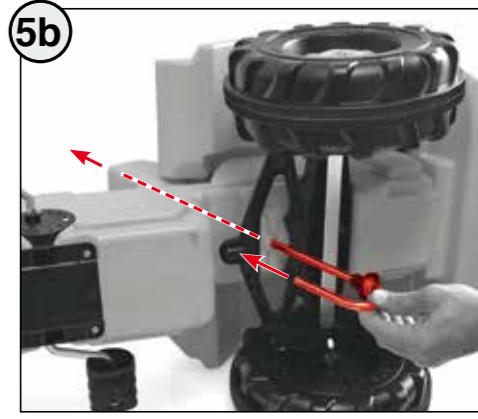

F 5x30 **G** $\varnothing 5\text{mm}$ **H** M5
1x 1x 1x

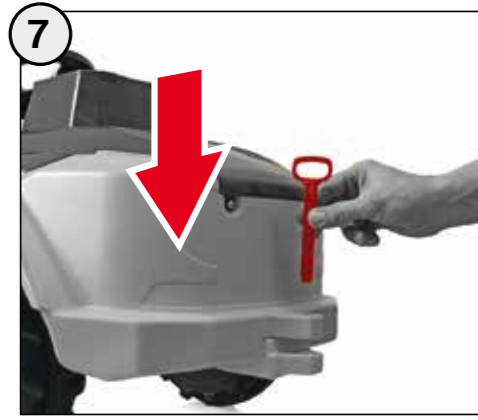
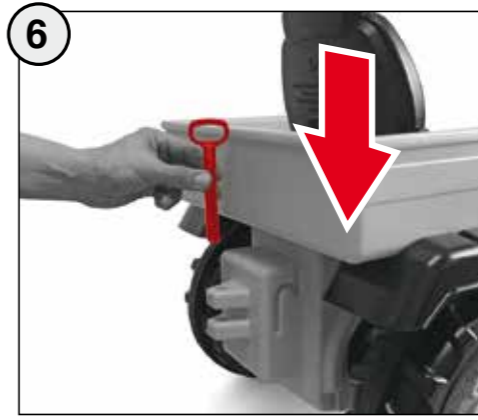
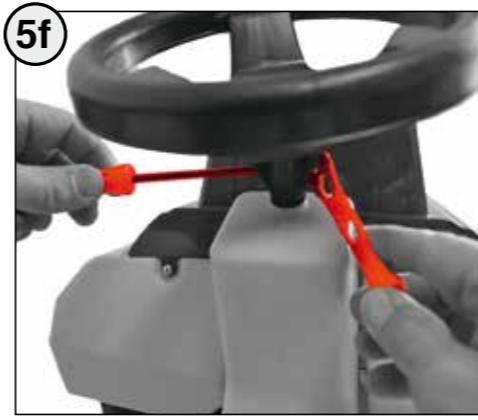

A 4 x 17
4x

B 5 x 40
6x

C M6
2x

D $\varnothing 15 \times \varnothing 6,4 \times 1$
2x

E $\varnothing 20 \times \varnothing 10,5 \times 1$
1x

F M5 x 30
1x

G $\varnothing 5\text{mm}$
1x

H M5
1x

0 10 20 30 40 50 mm (metrisch • metric • métrique • metrico)

