



rolly toys Kundendienst Deutschland:

Tel: +49 (0) 95 68 / 856-142

Fax: +49 (0) 95 68 / 856-183

e-mail: service@rollytoys.de

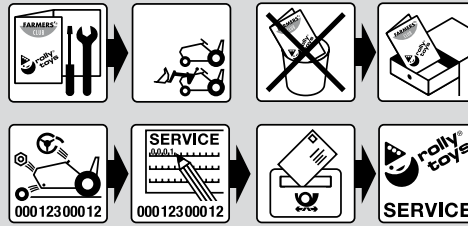

2022/02

640.000.801.00

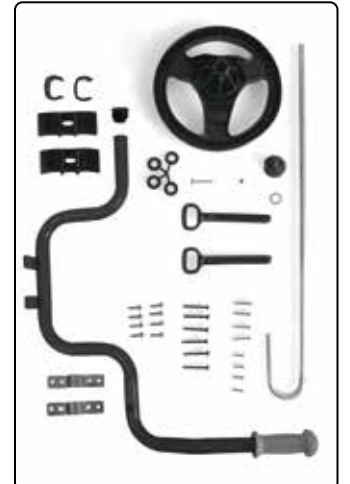
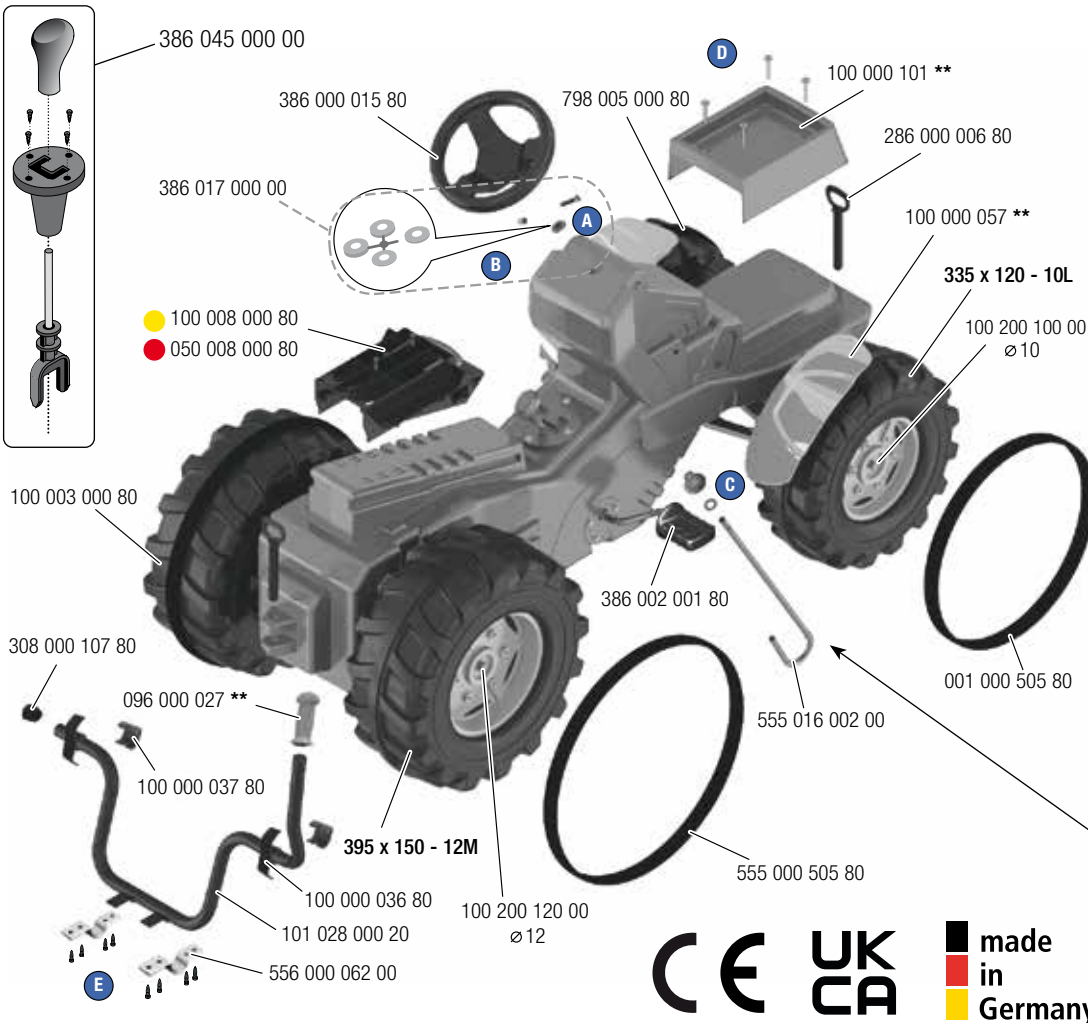

CE UK CA made in Germany

A M5 x 30
1x

B M5
1x

C ø20 x ø10,5 x 1
1x

D 4 x 20
4x

E 5 x 20
8x

0 10 20 30 40 50 mm
(metrisch • metric)

→ **

+10	+26	+47
+12	+30	+51
+13	+37	+54
+20	+40	+70
+22	+41	+75
+23	+44	+80



---NORTH & SOUTH AMERICA only---
180 days warranty
From the date of purchase + guaranteed spare part service
The warranty does not cover damages caused by improper use or neglect

Franz Schneider GmbH & Co KG
P.O.Box 1460
D-96459 · Neustadt bei Coburg · Germany
Tel.: +49 (0) 95 68 / 856-0
Fax.: +49 (0) 95 68 / 856-190
www.rollytoys.com

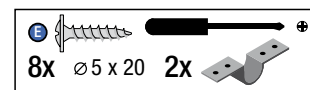
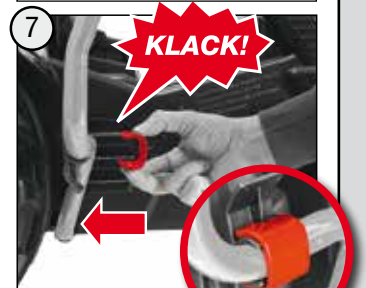
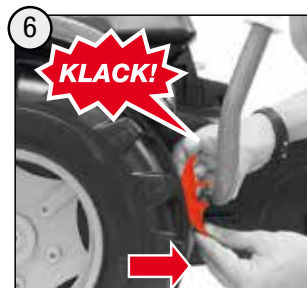
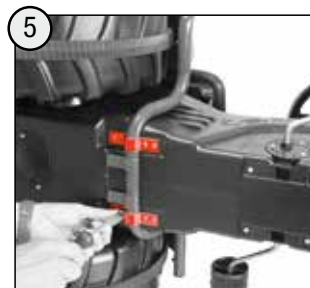
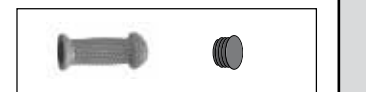
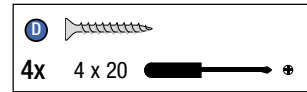
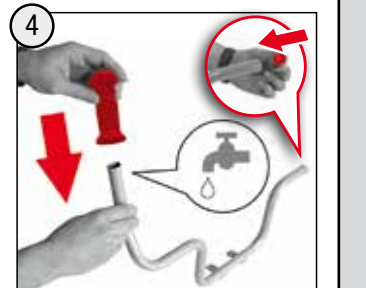
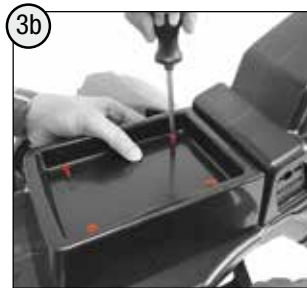
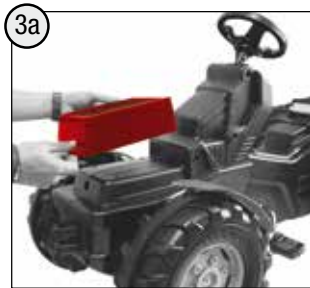
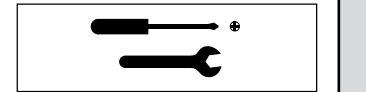
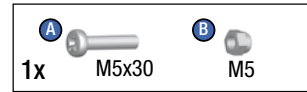
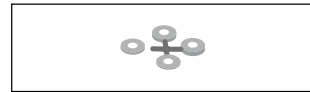
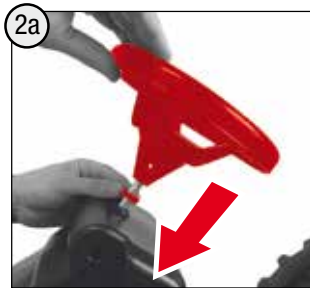
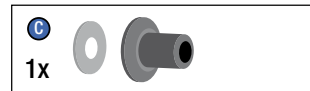
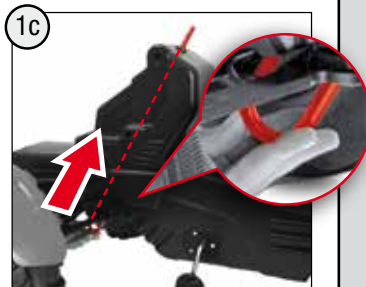
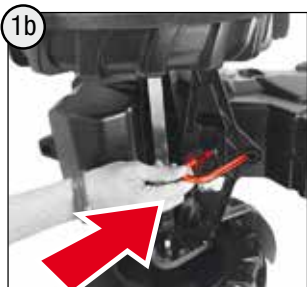
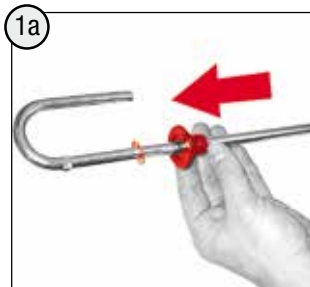

! WARNING

- CHOKING HAZARD - Small parts, Not for children under 3 years.
- Must be assembled by adults
- Adult supervision required.
- If toy is defective stop using it, repairs may only be carried out by adults.
- Never use near steps, slopes, driveways, hills, roadways, alleys or swimming pool areas.
- Always wear shoes.
- Never allow more than one rider.
- The use of protective gear and a safety helmet is highly recommended.
- The stickers are to be applied by adults only.
- Conforms to the requirements of ASTM Standard Consumer Safety Specification on Toy Safety, F 963.

! AVERTISSEMENT

- RISQUE D'ÉTOUFFEMENT - Petites pièces. Ne convient pas aux enfants de moins de 3 ans.
- Doit être assemblé par un adulte.
- Surveillance d'un adulte est requise.
- Si le jouet est défectueux, cessez de l'utiliser. Toute réparation ne doit être effectuée que par un adulte.
- Ne jamais utiliser à proximité des marches, des pentes, des allées, des collines, des routes, des allées ou des piscines.
- Portez toujours des chaussures.
- Ne permettez jamais la présence de plus d'un coureur.
- L'utilisation d'un équipement de protection et d'un casque de sécurité est fortement recommandée.
- Les autocollants ne doivent être appliqués que par des adultes.
- Conforme aux exigences de la norme internationale ASTM Standard Consumer Safety Specification on Toy Safety, F 963.

