

rolly toys Kundendienst Deutschland:

Tel: +49 (0) 95 68 / 856-142
Fax: +49 (0) 95 68 / 856-183
e-mail: service@rollytoys.de

2021/05

508.000.800.00

WARNING

- CHOKING HAZARD - Small parts, Danger of being swallowed. Contains small parts in non assembled state. Must be assembled by adults.
- Toy is not suitable to carry children.
- If toy is defective stop using it, repairs may only be carried out by adults.
- Adult supervision required.
- Never use near steps, slopes, driveways, hills, roadways, alleys or swimming pool areas.
- Always wear shoes.
- Conforms to the requirements of ASTM Standard Consumer Safety Specification on Toy Safety, F 963.

AVERTISSEMENT

- RISQUE D'ÉTOUFFEMENT - Petites pièces. Risque d'ingestion. Contient des petites pièces à l'état non assemblé. Doit être assemblé par un adulte.
- Le jouet ne convient pas au transport des enfants.
- Si le jouet est défectueux, cessez de l'utiliser. Toute réparation ne doit être effectuée que par un adulte.
- Surveillance d'un adulte requise.
- Ne jamais utiliser à proximité des marches, des pentes, des allées, des collines, des routes, des allées ou des piscines.
- Portez toujours des chaussures.
- Conforme aux exigences de la norme internationale ASTM Standard Consumer Safety Specification on Toy Safety, F 963.

<input type="checkbox"/>	rolly Dreiradtraktoren	05 ●●●●
<input type="checkbox"/>	rollyMinitrac	13 ●●●●
<input type="checkbox"/>	rollyKid	01 ●●●● / 02 ●●●●
<input checked="" type="checkbox"/>	rollyJunior	80 ●●●● / 81 ●●●●
<input checked="" type="checkbox"/>	rollyFarmtrac	60 ●●●● / 61 ●●●●
<input checked="" type="checkbox"/>	rollyFarmtrac Classic	03 ●●●● / 04 ●●●●
<input checked="" type="checkbox"/>	rollyFarmtrac Premium	70 ●●●● / 71 ●●●●
<input checked="" type="checkbox"/>	rollyX-Trac	03 ●●●● / 04 ●●●●
<input checked="" type="checkbox"/>	rollyTruck (Unimog)	03 ●●●●

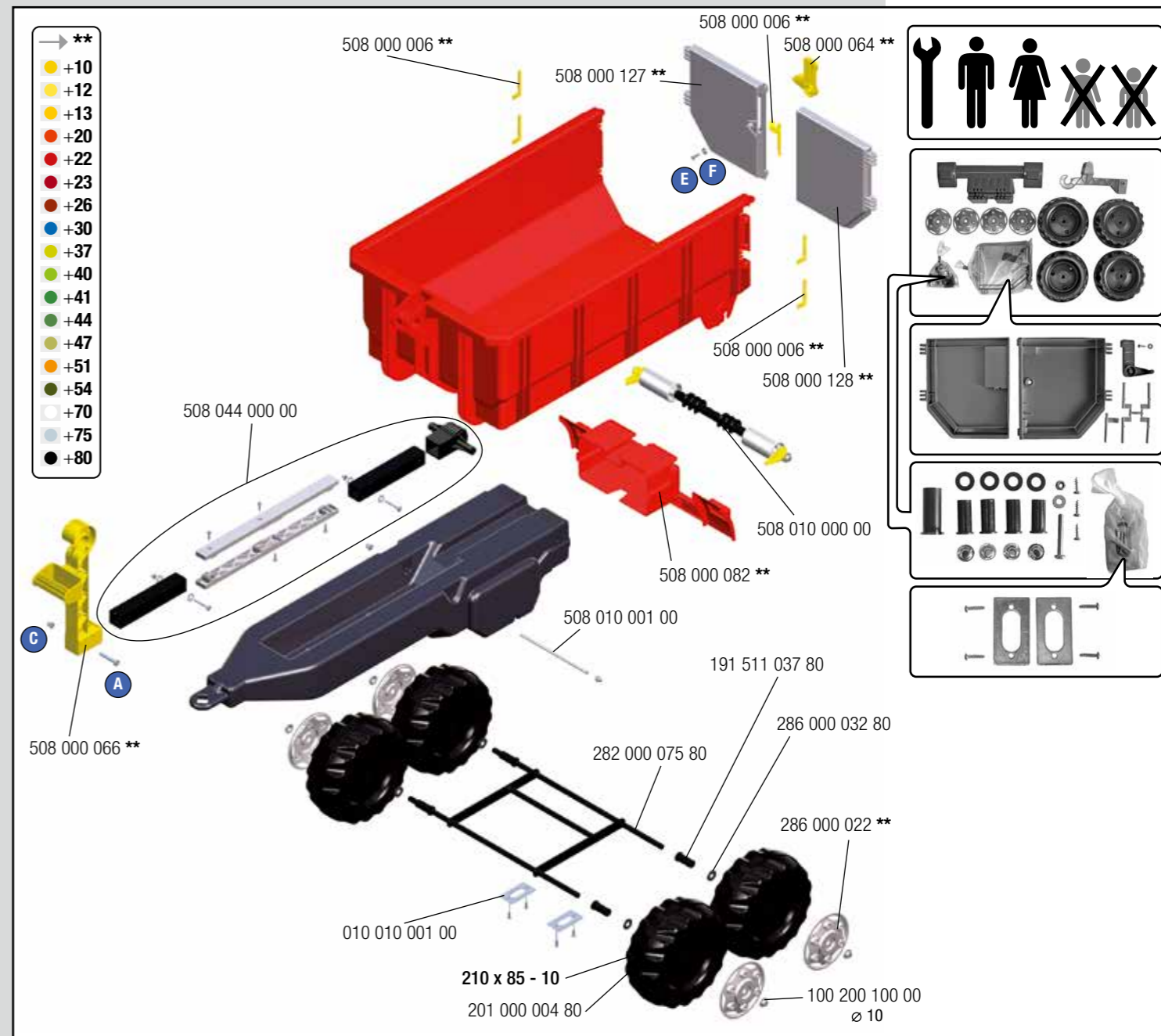

WARNING:

CHOKING HAZARD – Small parts.
Not for children under 3 years.

---NORTH & SOUTH AMERICA only---

180 days warranty

From the date of purchase + guaranteed spare part service
The warranty does not cover damages caused by improper use or neglect



Franz Schneider GmbH & Co KG
P.O.Box 1460
D-96459 · Neustadt bei Coburg · Germany
Tel.: +49 (0) 95 68 / 856-0
Fax.: +49 (0) 95 68 / 856-190
www.rollytoys.com

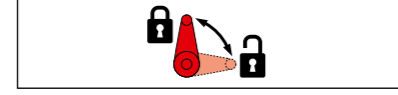
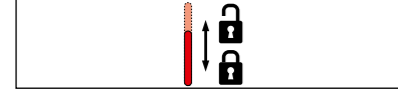
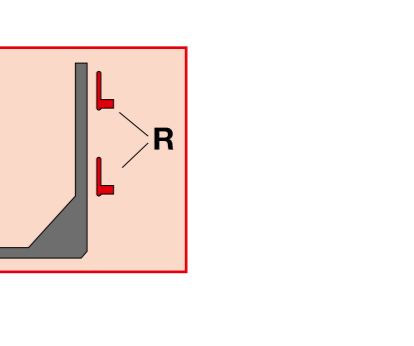
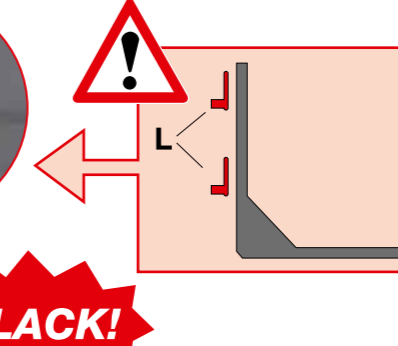
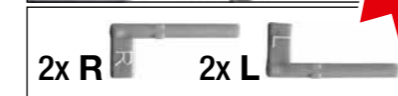
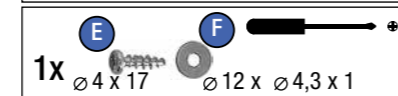
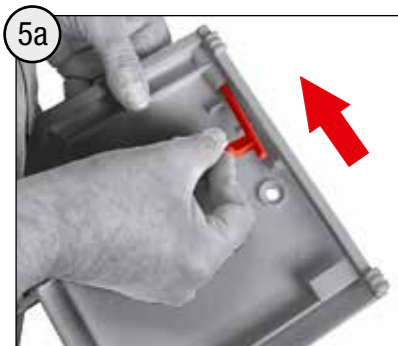
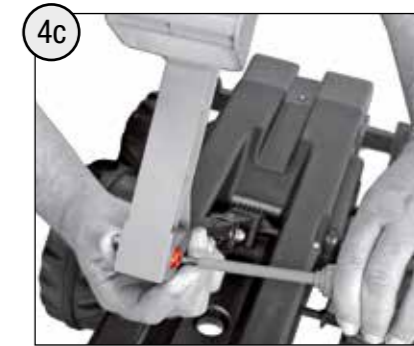
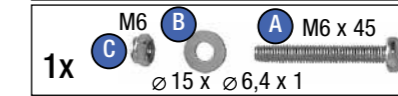
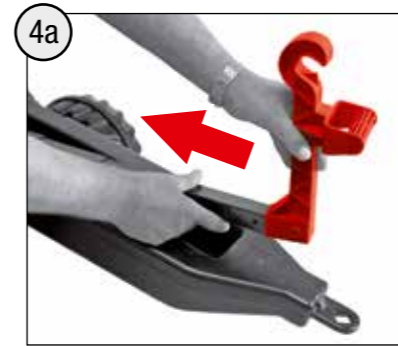
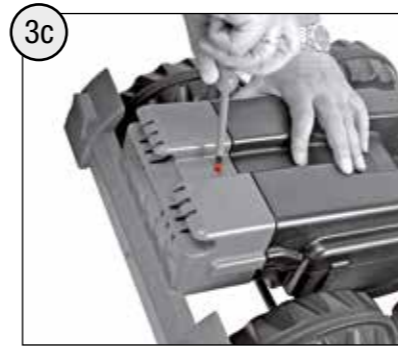
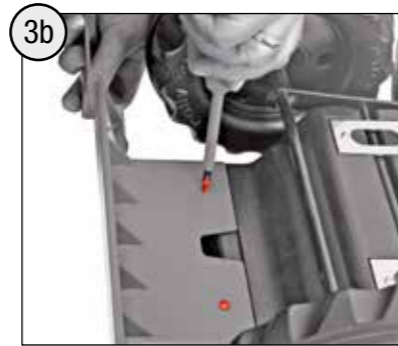
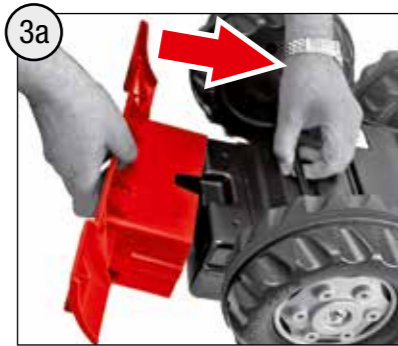
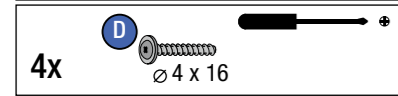
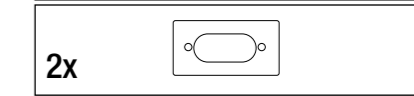
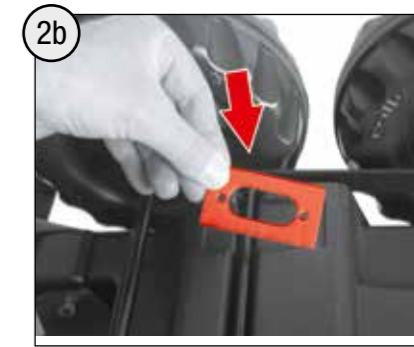
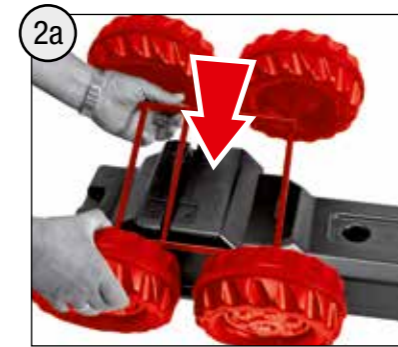
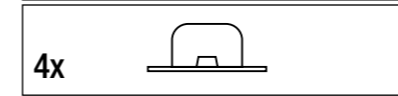
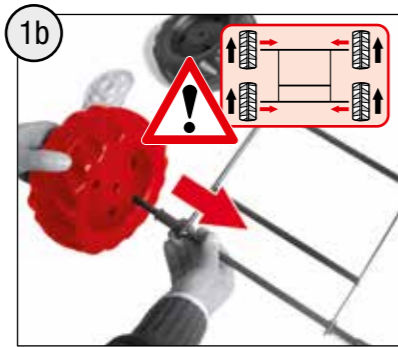
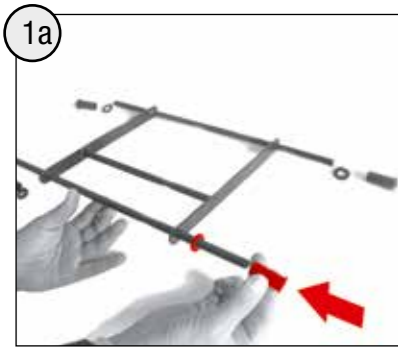

A M6 x 45
 1x

B ø 15 x ø 6,4 x 1
 1x

C M6
 1x

D ø 4 x 16
 4x

E ø 4 x 17
 4x

F ø 12 x ø 4,3 x 1
 1x

0 10 20 30 40 50 mm
 (metrisch • metric)