



rolly toys Kundendienst Deutschland:

Tel: +49 (0) 95 68 / 856-142

Fax: +49 (0) 95 68 / 856-183

e-mail: service@rollytoys.de

2018/08

508.000.800.00



WARNING:

CHOKING HAZARD – Small parts.
Not for children under 3 years.

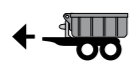

<input type="checkbox"/>	rolly Dreiradtraktoren	05 ...
<input type="checkbox"/>	rollyMinitrac	13 ...
<input type="checkbox"/>	rollyKid	01 ... / 02 ...
<input checked="" type="checkbox"/>	rollyJunior	80 ... / 81 ...
<input checked="" type="checkbox"/>	rollyFarmtrac	60 ... / 61 ...
<input checked="" type="checkbox"/>	rollyFarmtrac Classic	03 ... / 04 ...
<input checked="" type="checkbox"/>	rollyFarmtrac Premium	70 ... / 71 ...
<input checked="" type="checkbox"/>	rollyX-Trac	03 ... / 04 ...
<input checked="" type="checkbox"/>	rollyTruck (Unimog)	03 ...

WARNING

- CHOKING HAZARD - Small parts, Danger of being swallowed. Contains small parts in non assembled state. Must be assembled by adults.
- Toy is not suitable to carry children.
- If toy is defective stop using it, repairs may only be carried out by adults.
- Adult supervision required.
- Never use near steps, slopes, driveways, hills, roadways, alleys or swimming pool areas.
- Always wear shoes.
- Conforms to the requirements of ASTM Standard Consumer Safety Specification on Toy Safety, F 963.

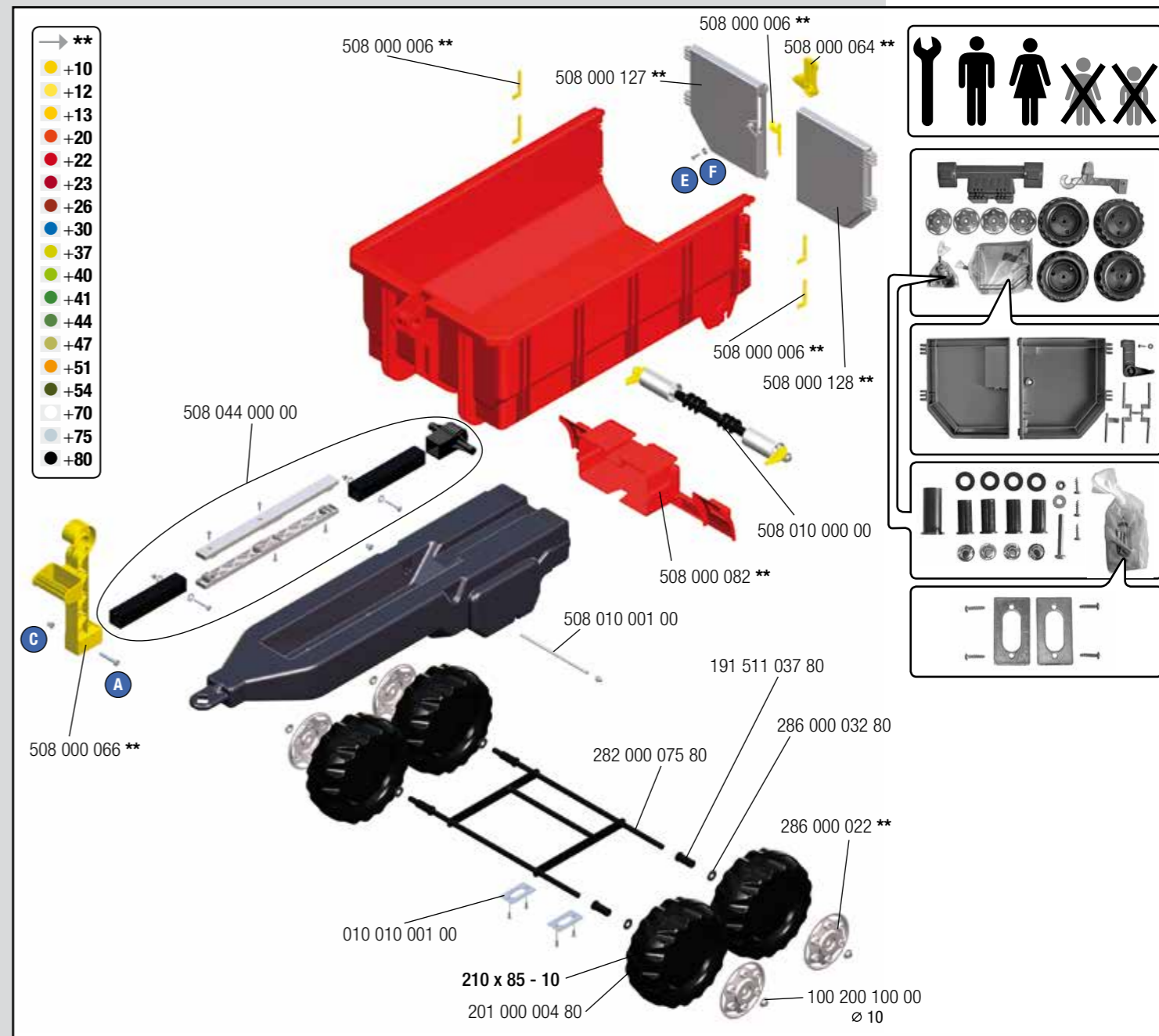

---NORTH & SOUTH AMERICA only---

180 days
warranty

From the date of purchase +
guaranteed spare part service

The warranty does not cover damages
caused by improper use or neglect



made
in
Germany



Franz Schneider GmbH & Co KG
P.O.Box 1460
D-96459 - Neustadt bei Coburg - Germany
Tel.: +49 (0) 95 68 / 856-0
Fax.: +49 (0) 95 68 / 856-190
www.rollytoys.com

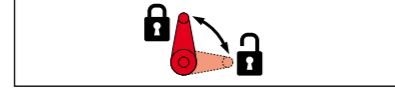
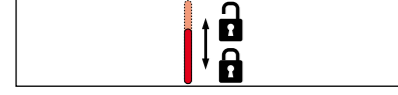
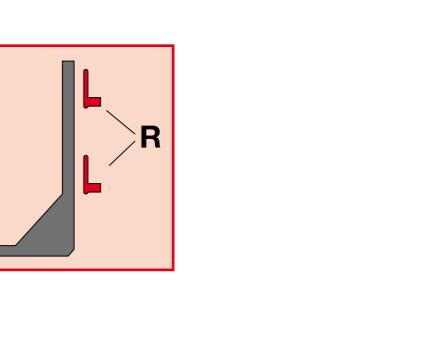
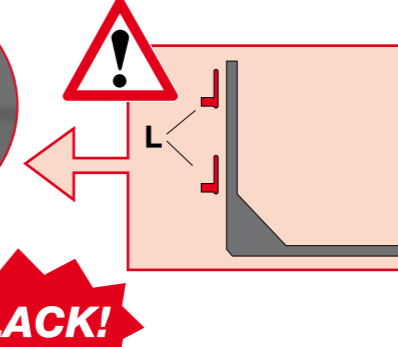
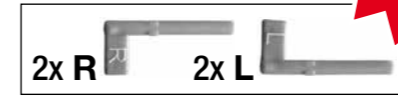
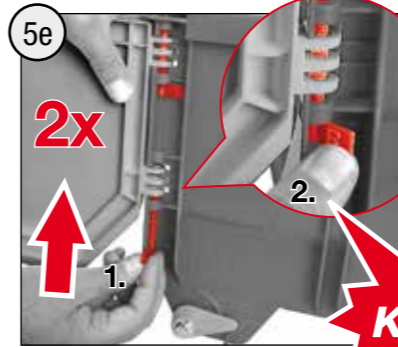
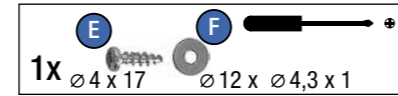
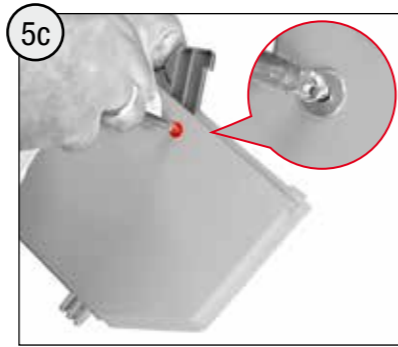
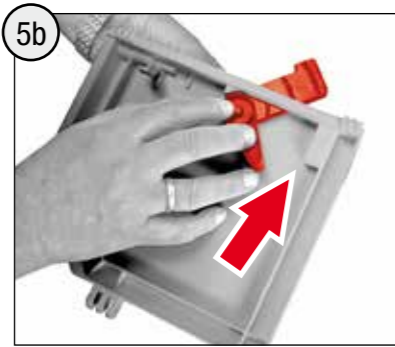
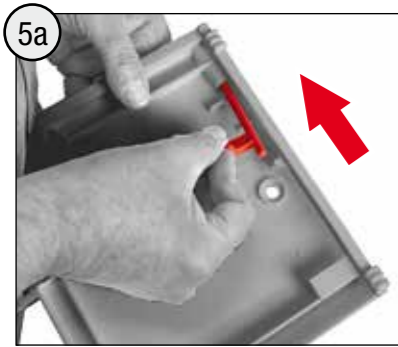
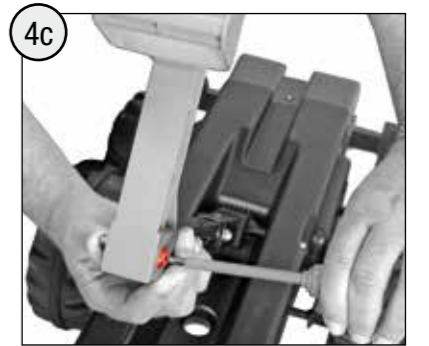
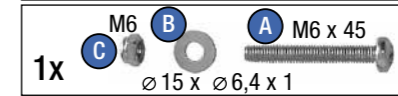
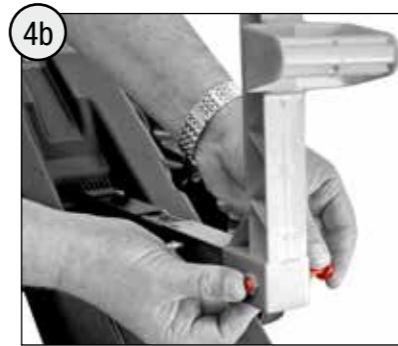
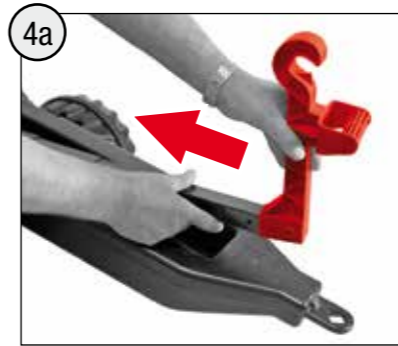
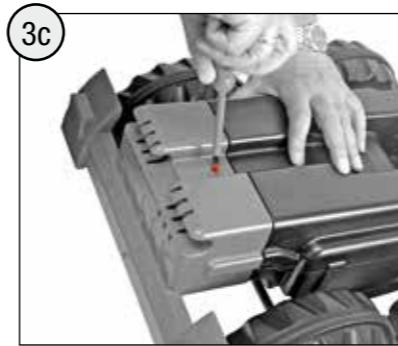
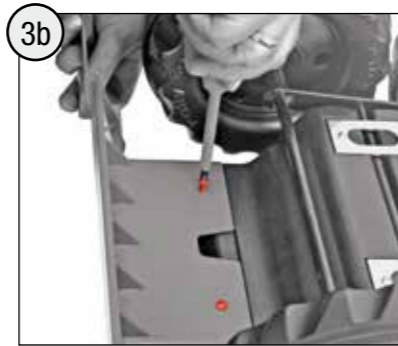
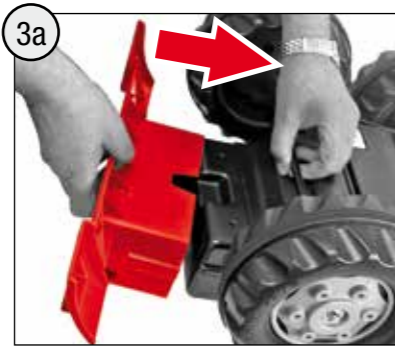
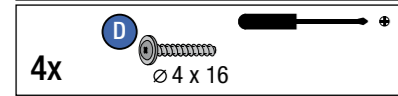
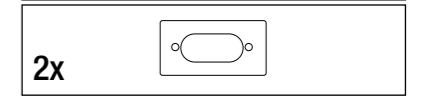
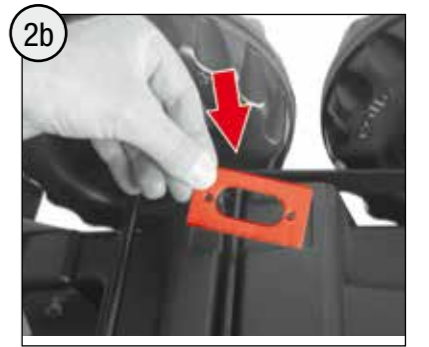
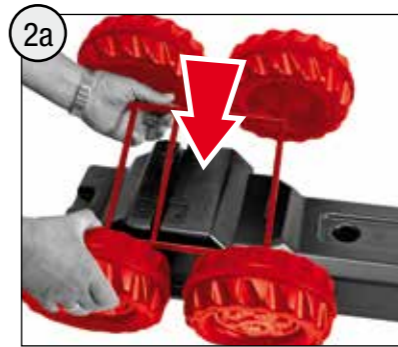
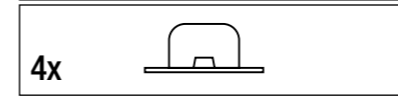
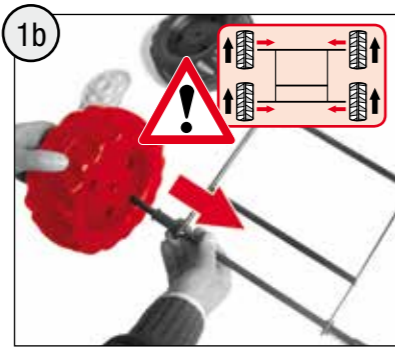
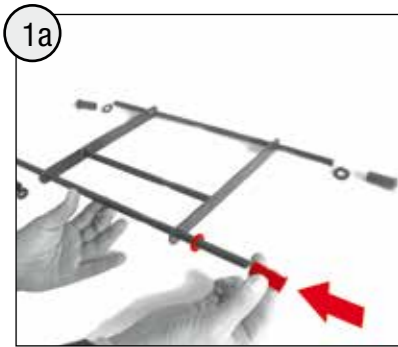

Parts list for steps 4a, 4b, 4c, 5e, 5f, 5g:

- A: 1x M6 x 45 screw
- B: 1x ø15 x ø6,4 x 1 washer
- C: 1x M6 nut
- D: 4x ø4 x 16 screw
- E: 4x ø4 x 17 screw
- F: 1x ø12 x ø4,3 x 1 washer

Scale: 0 10 20 30 40 50 mm (metrisch • metric)