

Ferbedo Truck

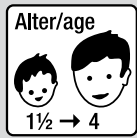

rolly toys Kundendienst Deutschland:

Tel: +49 (0) 95 68 / 856-142

Fax: +49 (0) 95 68 / 856-183

e-mail: service@rollytoys.de

2021/09

112.000.800.00

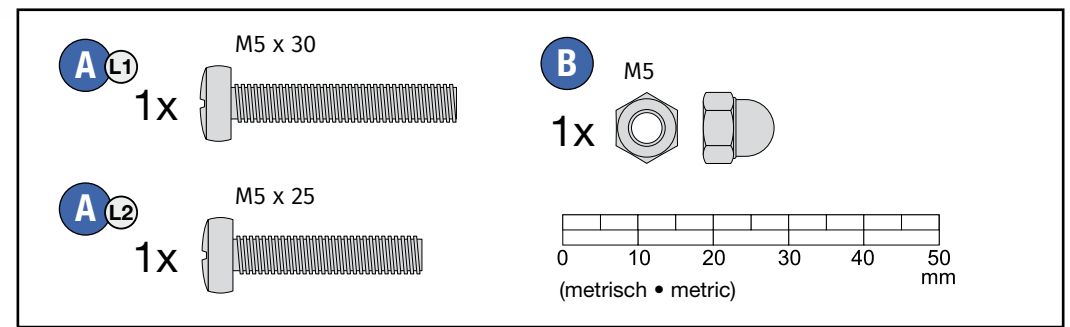
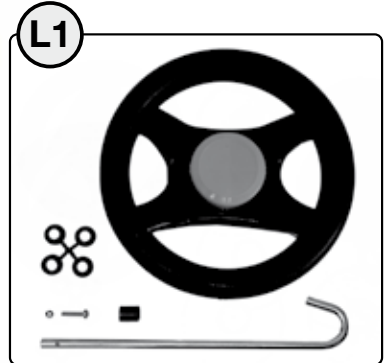
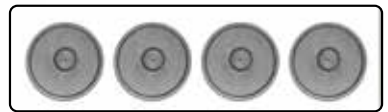
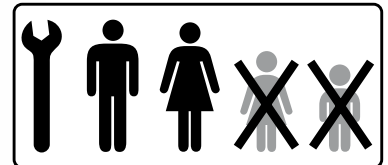
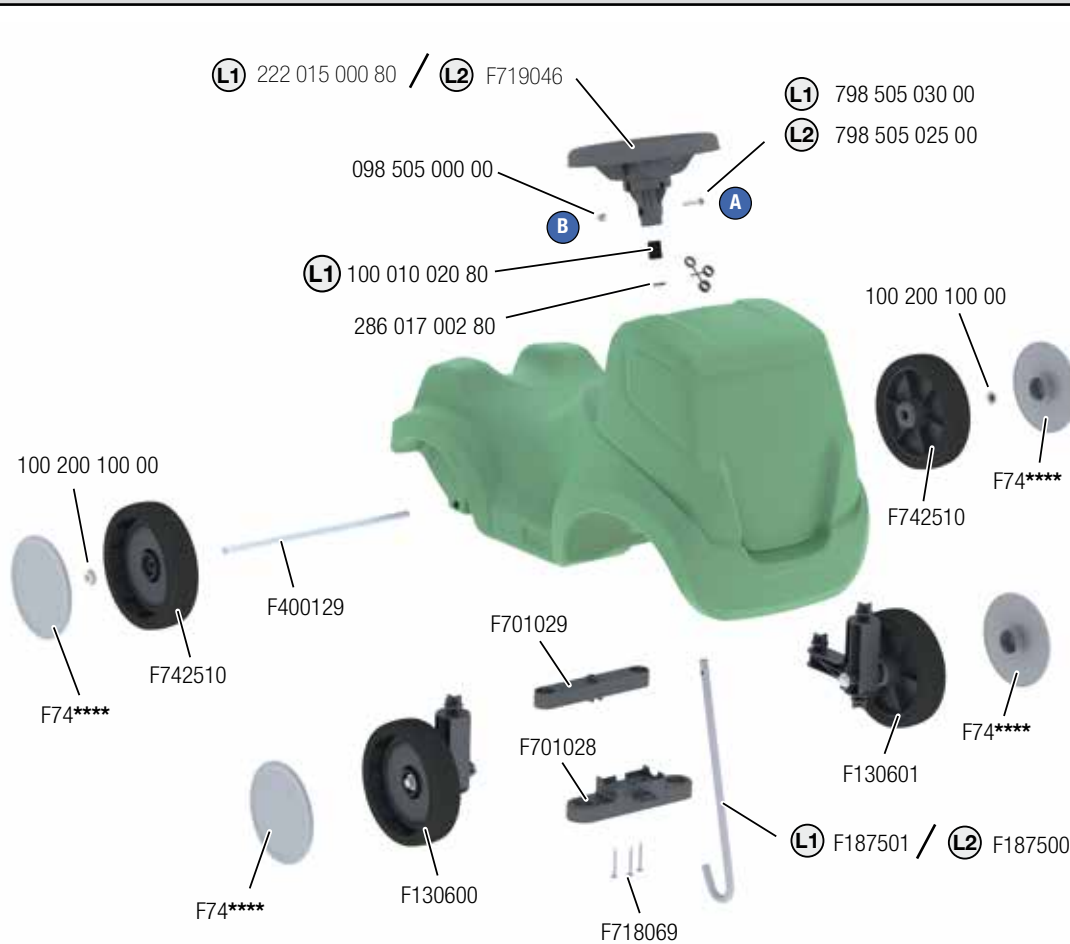

made in Germany

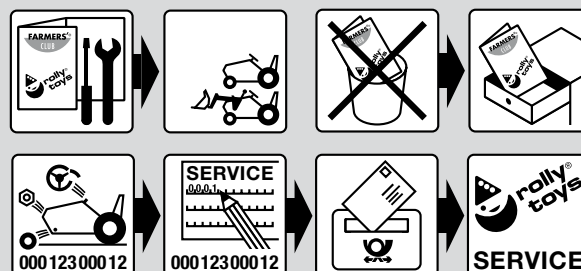

Franz Schneider GmbH & Co KG
 P.O.Box 1460
 D-96459 · Neustadt bei Coburg · Germany
 Tel.: +49 (0) 95 68 / 856-0
 Fax.: +49 (0) 95 68 / 856-190
www.rollytoys.com

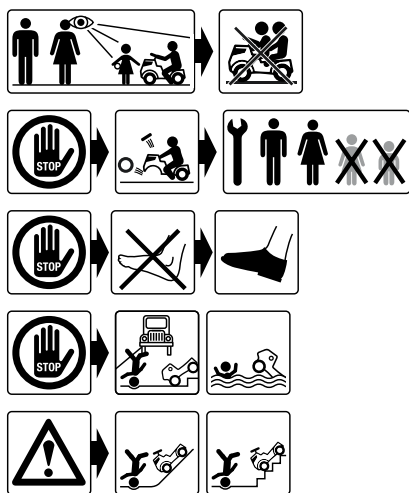
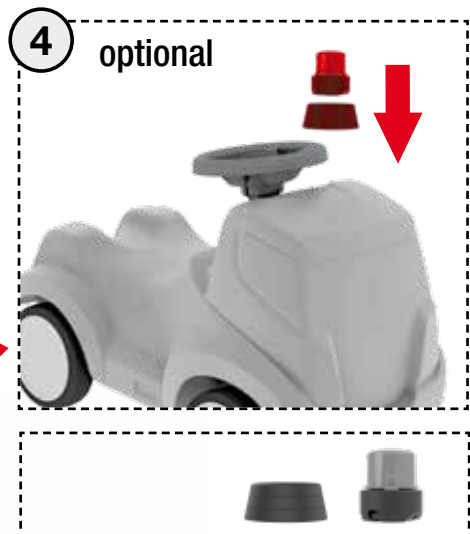
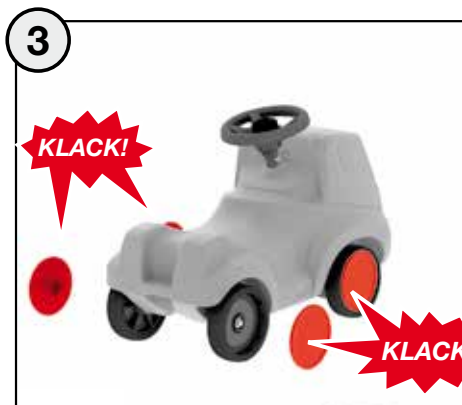
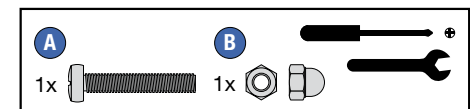
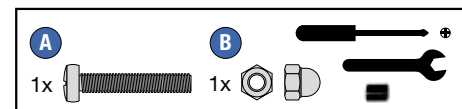
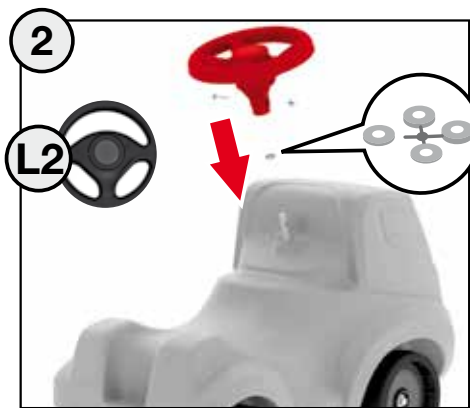
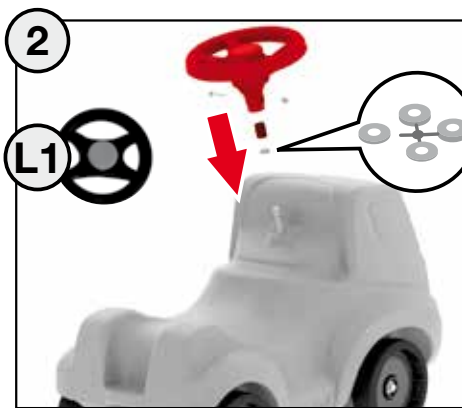
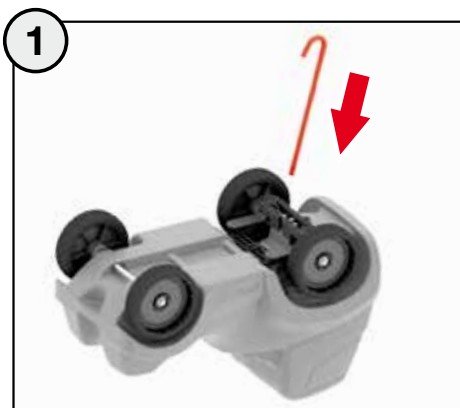

AVERTISSEMENT

- RISQUE D'ÉTOUFFEMENT - Petites pièces. Risque d'ingestion. Contient des petites pièces à l'état non assemblé. Doit être assemblé par un adulte.
- Surveillance d'un adulte est requise.
- Si le jouet est défectueux, cessez de l'utiliser.
- Toute réparation ne doit être effectuée que par un adulte.
- Ne jamais utiliser à proximité des marches, des pentes, des allées, des collines, des routes, des allées ou des piscines.
- Portez toujours des chaussures.
- Ne permettez jamais la présence de plus d'un coureur.
- L'utilisation d'un équipement de protection et d'un casque de sécurité est fortement recommandée.
- Les autocollants ne doivent être appliqués que par des adultes.
- Conforme aux exigences de la norme internationale ASTM Standard Consumer Safety Specification on Toy Safety, F 963.



WARNING

- CHOKING HAZARD - Small parts, Danger of being swallowed. Contains small parts in non assembled state. Must be assembled by adults.
- If toy is defective stop using it, repairs may only be carried out by adults.
- Adult supervision required.
- Never use near steps, slopes, driveways, hills, roadways, alleys or swimming pool areas.
- Always wear shoes.
- Never allow more than one rider.
- The use of protective gear and safety helmet is highly recommended.
- The stickers are to be applied by adults only.
- Conforms to the requirements of ASTM Standard Consumer Safety Specification on Toy Safety, F 963.

---NORTH & SOUTH AMERICA only---

180 days warranty

From the date of purchase + guaranteed spare part service

The warranty does not cover damages caused by improper use or neglect