



rolly toys Kundendienst Deutschland:

Tel: +49 (0) 95 68 / 856-142

Fax: +49 (0) 95 68 / 856-183

e-mail: service@rollytoys.de



2021/02

700.000.801.00

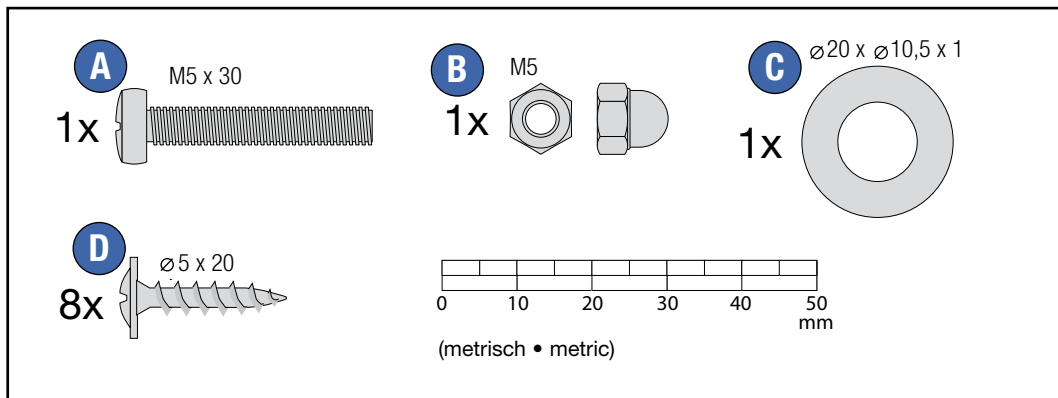
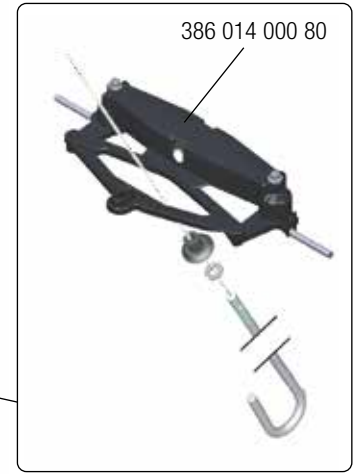
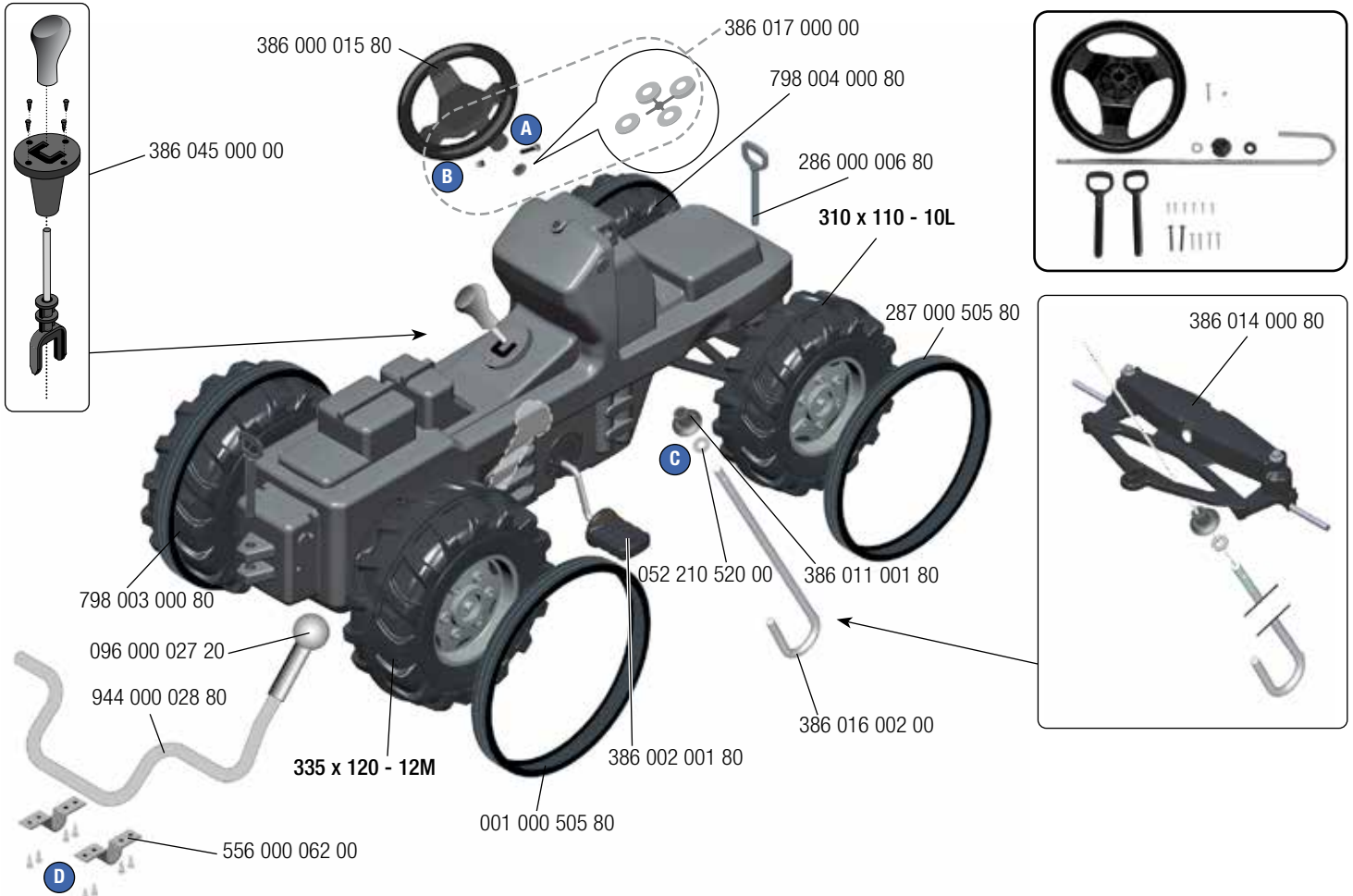

made
in
Germany

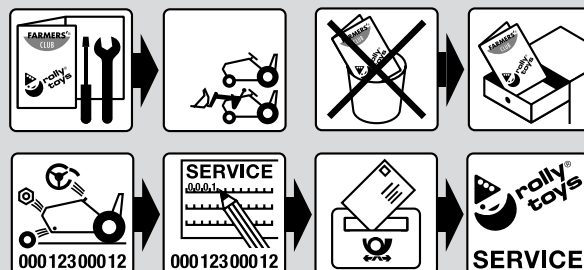

Franz Schneider GmbH & Co KG
P.O.Box 1460
D-96459 · Neustadt bei Coburg · Germany
Tel.: +49 (0) 95 68 / 856-0
Fax.: +49 (0) 95 68 / 856-190
www.rollytoys.com

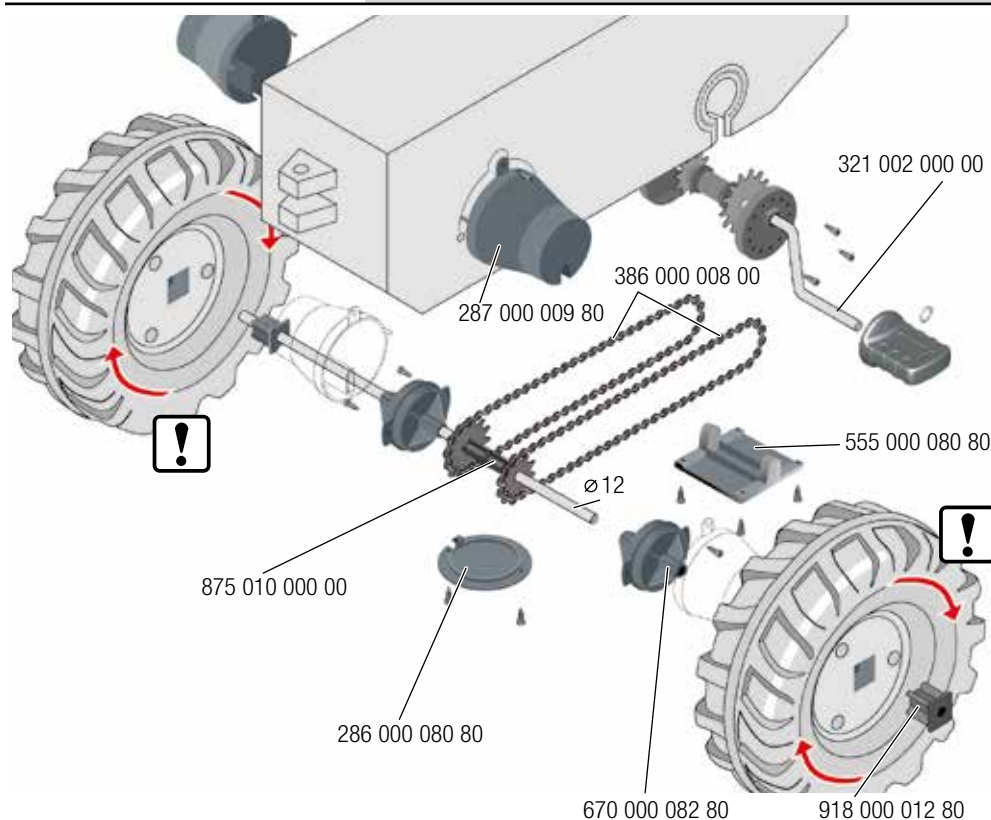
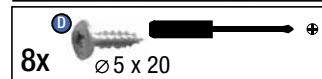
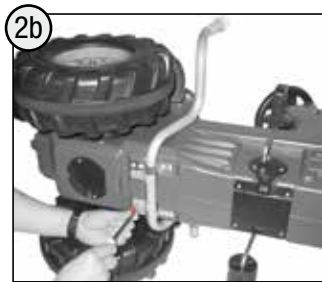
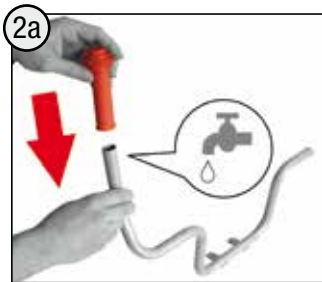
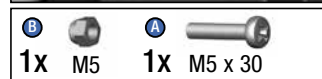
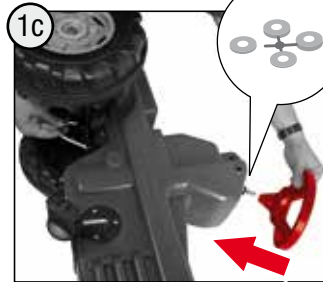
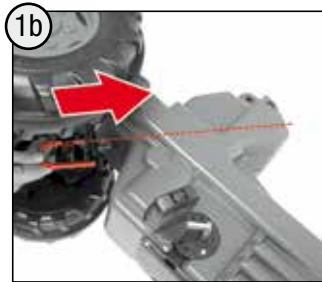
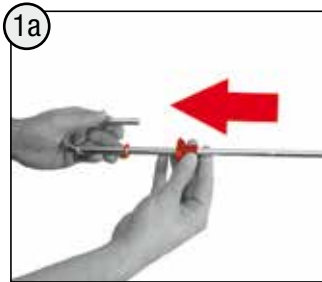

---NORTH & SOUTH AMERICA only---

180 days warranty

From the date of purchase + guaranteed spare part service

The warranty does not cover damages caused by improper use or neglect



WARNING

- **CHOKING HAZARD:** Small parts. Danger of being swallowed. Contains small parts in non assembled state. Must be assembled by adults.
- Adult supervision required.
- Never use near steps, slopes, driveways, hills, roadways, alleys or swimming pool areas.
- Always wear shoes.
- Never allow more than one rider.
- The use of protective gear and a safety helmet is highly recommended.
- Conforms to the requirements of ASTM Standard Consumer Safety Specification on Toy Safety, F 963
- Not suitable for children under 3 years.