

rollyTrac Lader Premium

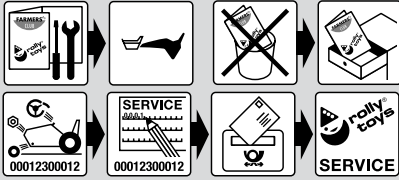
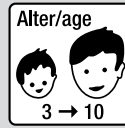

rollytoys Kundendienst Deutschland:

Tel: +49 (0) 95 68 / 856-142

Fax: +49 (0) 95 68 / 856-183

e-mail: service@rollytoys.de

2016/09

101.000.800.00

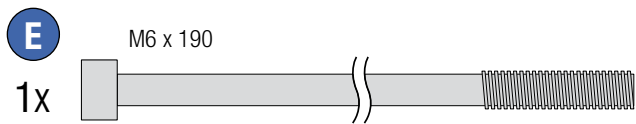
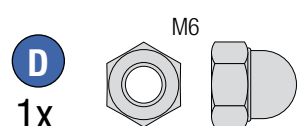
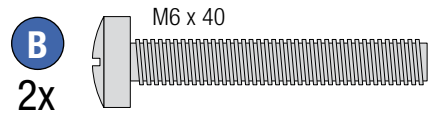
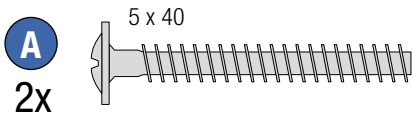
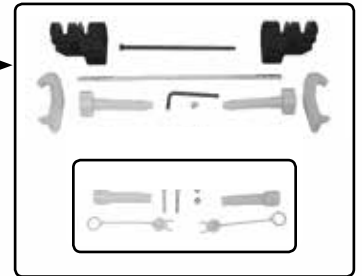
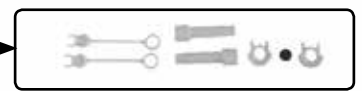
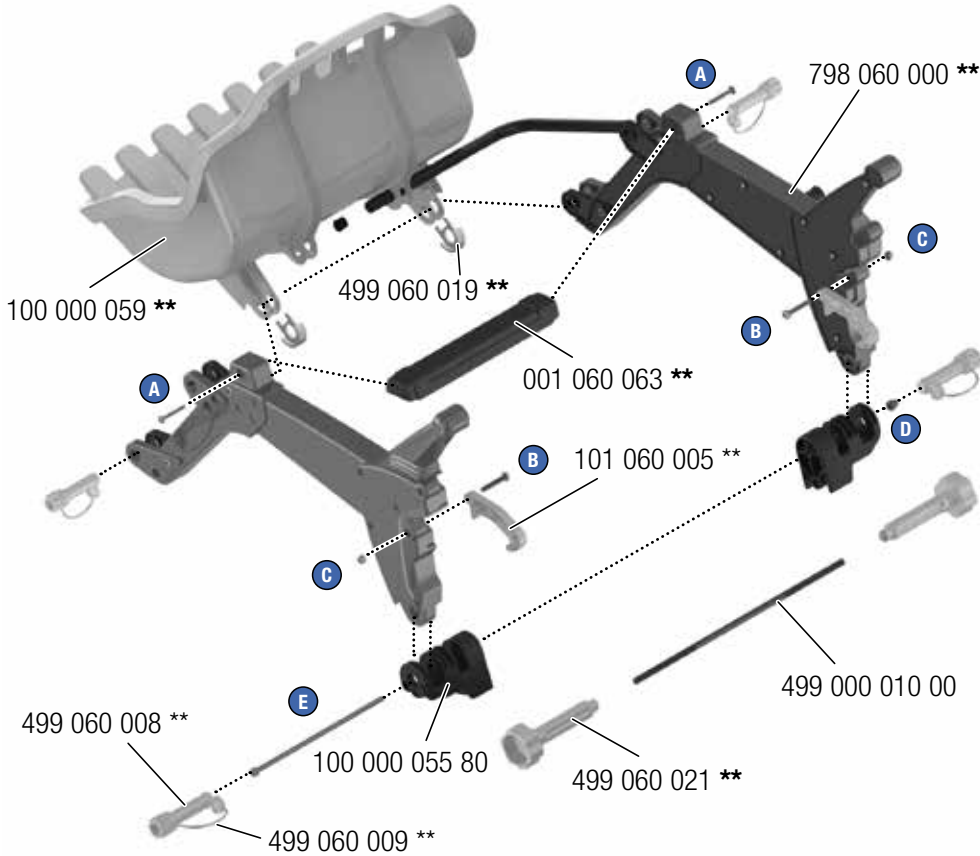

→ **	+10	+26	+70
	+12	+30	+75
	+13	+37	+78
	+20	+40	+80
	+22	+41	
	+23	+44	

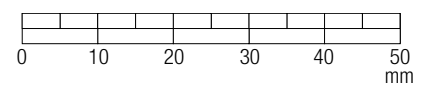

(metrisch • metric)



--NORTH & SOUTH AMERICA only--
180 days warranty

From the date of purchase + guaranteed spare part service

The warranty does not cover damages caused by improper use or neglect

WARNING

- CHOKING HAZARD: Small parts. Danger of being swallowed. Contains small parts in non assembled state. Must be assembled by adults.
- Adult supervision required.
- Never use near steps, slopes, driveways, hills, roadways, alleys or swimming pool areas.
- Always wear shoes.
- Never allow more than one rider.
- The use of protective gear and a safety helmet is highly recommended.
- Conforms to the requirements of ASTM Standard Consumer Safety Specification on Toy Safety, F 963



Franz Schneider GmbH & Co KG

P.O.Box 1460

D-96459 · Neustadt bei Coburg · Germany

Tel.: +49 (0) 95 68 / 856-0

Fax.: +49 (0) 95 68 / 856-190

www.rollytoys.com · e-mail: service@rollytoys.de

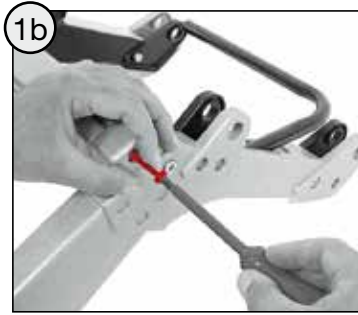
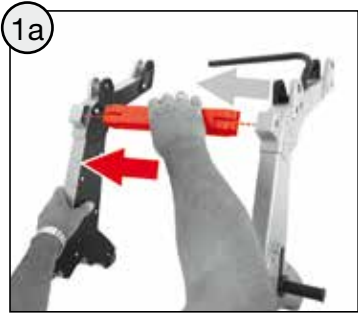

B
1x 5 x 40

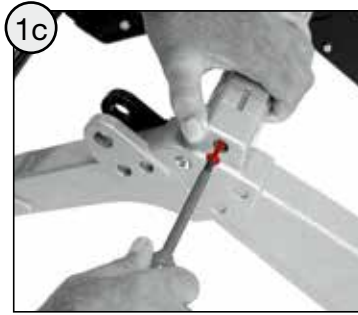

B
1x 5 x 40

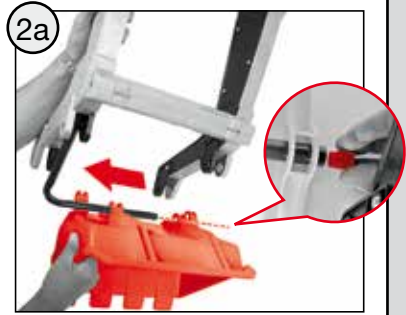

1x

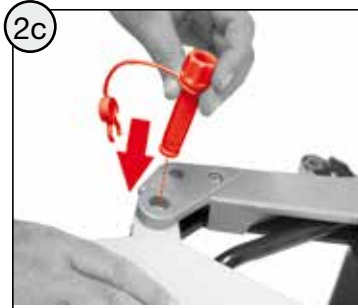
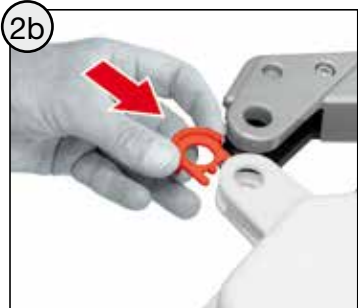

2x

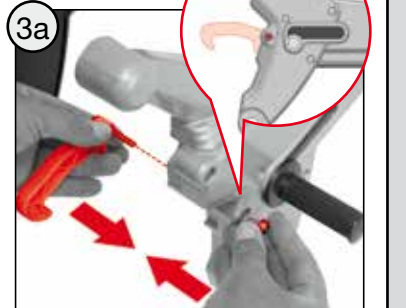

A M6 x 40 **C** M6
1x 1x 1x

2x

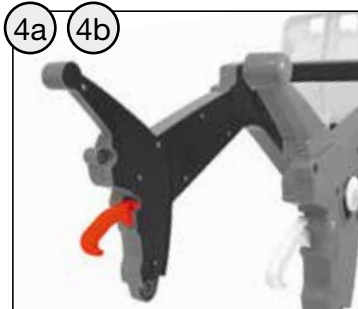
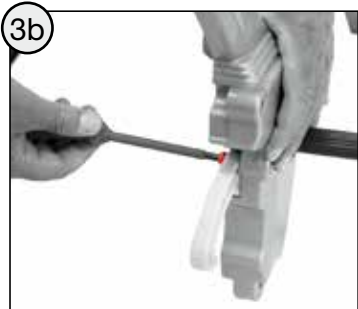

A M6 x 40 **C** M6
1x 1x 1x



E M6 x 190

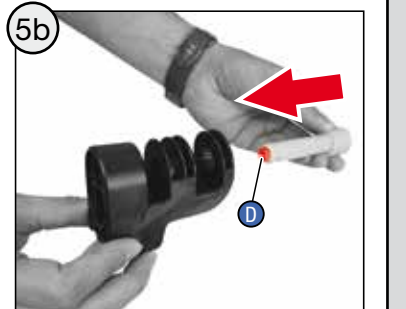

D M6

+



1x

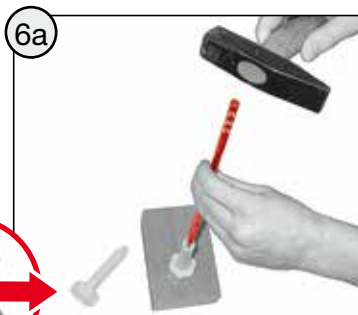

1x $\varnothing 8 \times 335\text{mm}$

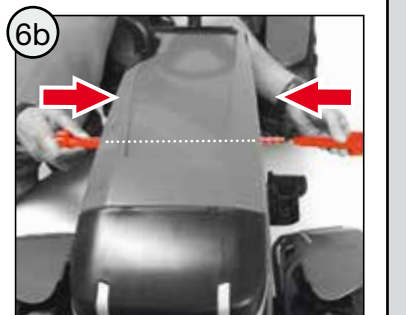

1x

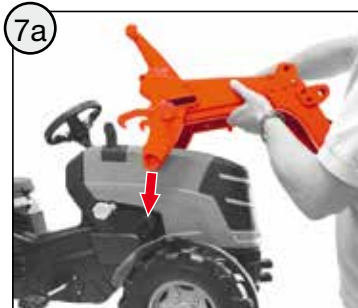
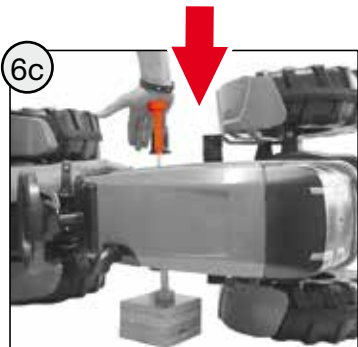

2x

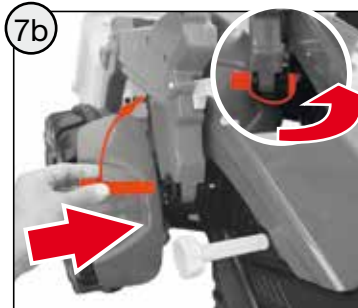

2x

